

KOMPLETNÍ CENÍK NÁHRADNÍCH DÍLŮ - VENKOVNÍ ROLETA VIVERA (výrobce ISOTRA)

Venkovní roleta Vivera / Vivera-Sectra

Základní specifikace produktu

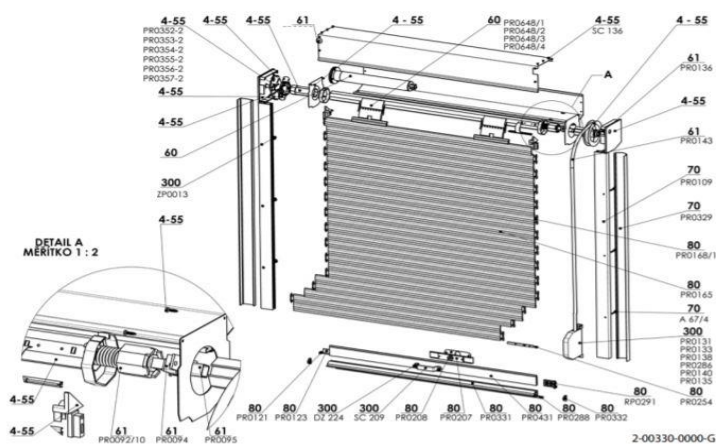

Ovládání

Šňůra

Pásek

















Klika

















Pružina













- slouží k vytahování a spouštění rolety. Šňůra ø 4,5 mm v barvě bílé nebo hnědé.
- slouží k vytahování a spouštění rolety. Pásek šíře 14 mm v barvě bílé nebo hnědé.
- slouží k vytahování a spouštění rolety. Klika - vyrobena z plastu a oceli (trubka ø 15,5 mm nebo ø 13 mm).
Příchod kliky pod úhlem 45° nebo 90°.
- slouží k vytahování a spouštění rolety. Roleta je ovládaná ručně, přičemž zpětné navinutí rolety zajišťuje předepjatá pružina, který je uložená v hřídeli. Nutno použít lamety bez otvorů v zámku. Nutno použít zámeček nebo







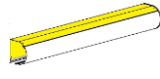
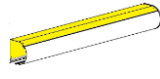
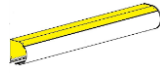









| nákres, Picture, Zeichnung | Obchodní název, | zkratka | název, materiál | PRODEJNÍ CENA VČ. 21% DPH) bez dopravy | jednotka, |
|---|-----------------|---------------|--|---|-----------|
|  | PR0123 | 6-001869-0000 | Závaží koncové lišty 18x3 | 133,33 Kč | m |
|  | PR0131/0100 | 6-001908-0100 | Selve-páskový navijec, bez pásku-BÍLÝ | 273,00 Kč | ks |
|  | PR0131/0200 | 6-001908-0200 | Selve-páskový navijec, bez pásku-HNĚDÝ | 281,80 Kč | ks |
|  | PR0133/0100 | 6-001913-0100 | Selve-páskový zapuštěný navijec, bez pásku-BÍLÝ | 356,03 Kč | ks |
|  | PR0133/0200 | 6-001913-0200 | Selve-páskový zapuštěný navijec, bez pásku-HNĚDÝ | 317,03 Kč | ks |
|  | PR0135/0100 | 6-001911-0100 | Selve-šňůrový navijec, bez šňůry-BÍLÝ | 319,53 Kč | ks |
|  | PR0135/0200 | 6-001911-0200 | Selve-šňůrový navijec, bez šňůry-HNĚDÝ | 328,33 Kč | ks |
|  | PR0136/0100 | 6-001920-0100 | Pásková rolna - BÍLÁ | 197,55 Kč | ks |
|  | PR0136/0200 | 6-001920-0200 | Pásková rolna - HNĚDÁ | 197,55 Kč | ks |

| | | | | | |
|---|-------------|---------------|---|-------------|----|
|  | PR0138/0100 | 6-001914-0100 | Selve-navíječ páskový klikový bez pásku-BÍLÝ | 1 827,83 Kč | ks |
|  | PR0138/0200 | 6-001914-0200 | Selve-navíječ páskový klikový bez pásku-HNĚDÝ | 2 194,53 Kč | ks |
|  | PR0139/01 | 6-001925-0001 | Madlo - pro snadné ovládání šňůry - BÍLÉ | 283,05 Kč | ks |
|  | PR0140/0100 | 6-001954-0100 | Selve-šňůrový- klikový navíječ, bez šňůry - BÍLÝ | 1 899,53 Kč | ks |
|  | PR0140/0200 | 6-001954-0200 | Selve-šňůrový- klikový navíječ, bez šňůry - HNĚDÝ | 2 323,45 Kč | ks |
|  | PR0143/0100 | 6-001916-0100 | Pásek 14 mm šedý | 20,13 Kč | m |
|  | PR0143/0200 | 6-001916-0200 | Pásek 14 mm hnědý | 22,65 Kč | m |
|  | PR0144/0100 | 6-001915-0100 | Šňůra - BÍLÁ | 26,40 Kč | m |
|  | PR0144/0200 | 6-001915-0200 | Šňůra HNĚDÁ | 30,20 Kč | m |
|  | PR0146/0100 | 6-001918-0100 | Pásková průchodka, mini - BÍLÁ | 42,78 Kč | ks |
|  | PR0146/0200 | 6-001918-0200 | Pásková průchodka, mini - HNĚDÁ | 49,08 Kč | ks |
|  | PR0148/0100 | 6-001923-0100 | Šňůrová převáděcí rolna - BÍLÁ | 111,95 Kč | ks |
|  | PR0148/0200 | 6-001923-0200 | Šňůrová převáděcí rolna - HNĚDÁ | 111,95 Kč | ks |
|  | PR0150 | 6-002485-0000 | Spirálová průchodka 200 | 104,43 Kč | ks |
|  | PR0001/00 | 6-001701-0000 | Válcovaná schránka, úkos 20°, GUTS 125 - bezbarvá | 337,15 Kč | m |
|  | PR0001/01 | 6-001701-0001 | Válcovaná schránka, úkos 20°, GUTS 125 - bílá | 353,48 Kč | m |









| | | | | | |
|---|-----------|---------------|---|-----------|---|
|  | PR0001/03 | 6-001701-0003 | Válcovaná schránka, úkos 20°, GUTS 125 - hnědá | 353,48 Kč | m |
|  | PR0002/00 | 6-001706-0000 | Válcovaná schránka, úkos 20°, GUTS 138 - bezbarvá | 359,78 Kč | m |
|  | PR0002/01 | 6-001706-0001 | Válcovaná schránka, úkos 20°, GUTS 138 - bílá | 366,05 Kč | m |
|  | PR0002/03 | 6-001706-0003 | Válcovaná schránka, úkos 20°, GUTS 138 - hnědá | 366,05 Kč | m |
|  | PR0003/00 | 6-001712-0000 | Válcovaná schránka, úkos 20°, GUTS 150 - bezbarvá | 421,40 Kč | m |
|  | PR0003/01 | 6-001712-0001 | Válcovaná schránka, úkos 20°, GUTS 150 - bílá | 430,23 Kč | m |
|  | PR0003/03 | 6-001712-0003 | Válcovaná schránka, úkos 20°, GUTS 150 - hnědá | 430,23 Kč | m |
|  | PR0004/00 | 6-001718-0000 | Válcovaná schránka, úkos 20°, GUTS 165 - bezbarvá | 467,98 Kč | m |
|  | PR0004/01 | 6-001718-0001 | Válcovaná schránka, úkos 20°, GUTS 165 - bílá | 475,50 Kč | m |
|  | PR0004/03 | 6-001718-0003 | Válcovaná schránka, úkos 20°, GUTS 165 - hnědá | 475,50 Kč | m |
|  | PR0005/00 | 6-001723-0000 | Válcovaná schránka, úkos 20° GUTS 180 - bezbarvá | 498,13 Kč | m |
|  | PR0005/01 | 6-001723-0001 | Válcovaná schránka, úkos 20° GUTS 180 - bílá | 506,95 Kč | m |
|  | PR0005/03 | 6-001723-0003 | Válcovaná schránka, úkos 20° GUTS 180 - hnědá | 506,95 Kč | m |
|  | PR0006/00 | 6-001726-0000 | Válcovaná schránka, úkos 20° GUTS 205 - bezbarvá | 606,38 Kč | m |
|  | PR0006/01 | 6-001726-0001 | Válcovaná schránka, úkos 20° GUTS 205 - bílý | 630,28 Kč | m |
|  | PR0006/03 | 6-001726-0003 | Válcovaná schránka, úkos 20° GUTS 205 - hnědá | 630,28 Kč | m |

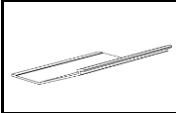
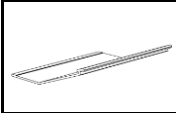
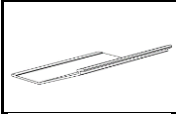
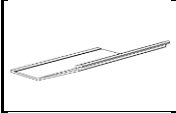
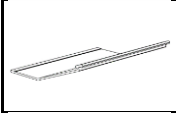
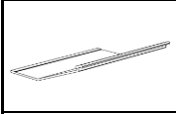
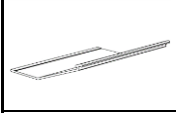















| | | | | | |
|---|-----------|---------------|--|-------------|---|
|  | PR0013/00 | 6-001887-0000 | Válcovaná schránka, zaoblená RUS 138 - bezbarvá | 526,58 Kč | m |
|  | PR0013/01 | 6-001887-0001 | Válcovaná schránka, zaoblená RUS 138 - bílá | 538,18 Kč | m |
|  | PR0013/03 | 6-001887-0003 | Válcovaná schránka, zaoblená RUS 138 - hnědá | 818,95 Kč | m |
|  | PR0014/00 | 6-001892-0000 | Válcovaná schránka, zaoblená RUS 165 - bezbarvá | 588,83 Kč | m |
|  | PR0014/01 | 6-001892-0001 | Válcovaná schránka, zaoblená RUS 165 - bílá | 610,50 Kč | m |
|  | PR0014/03 | 6-001892-0003 | Válcovaná schránka, zaoblená RUS 165 - hnědá | 896,93 Kč | m |
|  | PR0015/00 | 6-002549-0000 | Válcovaná schránka, zaoblená RUS 180 - bezbarvá | 640,95 Kč | m |
|  | PR0015/01 | 6-002549-0001 | Válcovaná schránka, zaoblená RUS 180 - bílá | 671,25 Kč | m |
|  | PR0015/03 | 6-002549-0003 | Válcovaná schránka, zaoblená RUS 180 - hnědá | 954,80 Kč | m |
|  | PR0016/00 | 6-002547-0000 | Válcovaná schránka, zaoblená RUS 205 - bezbarvá | 766,73 Kč | m |
|  | PR0016/01 | 6-002547-0001 | Válcovaná schránka, zaoblená RUS 205 - bílá | 807,28 Kč | m |
|  | PR0016/03 | 6-002547-0003 | Válcovaná schránka, zaoblená RUS 205 - hnědá | 1 125,05 Kč | m |
|  | PR0017/00 | 6-001888-0000 | Válcovaná schránka, čtvrtkulatá VRB 138 - bezbarvá | 526,58 Kč | m |
|  | PR0017/01 | 6-001888-0001 | Válcovaná schránka, čtvrtkulatá VRB 138 - bílá | 538,18 Kč | m |
|  | PR0017/03 | 6-001888-0003 | Válcovaná schránka, čtvrtkulatá VRB 138 - hnědá | 538,18 Kč | m |
|  | PR0018/00 | 6-001893-0000 | Válcovaná schránka, čtvrtkulatá VRB 165 - bezbarvá | 620,70 Kč | m |

















| | | | | | |
|---|-----------|---------------|--|-------------|---|
|  | PR0018/01 | 6-001893-0001 | Válcovaná schránka, čtvrtkulatá VRB 165 - bílá | 620,70 Kč | m |
|  | PR0018/03 | 6-001893-0003 | Válcovaná schránka, čtvrtkulatá VRB 165 - hnědá | 620,70 Kč | m |
|  | PR0019/00 | 6-001895-0000 | Válcovaná schránka, čtvrtkulatá VRB 180 - bezbarvá | 721,95 Kč | m |
|  | PR0019/01 | 6-001895-0001 | Válcovaná schránka, čtvrtkulatá VRB 180 - bílá | 743,60 Kč | m |
|  | PR0019/03 | 6-001895-0003 | Válcovaná schránka, čtvrtkulatá VRB 180 - hnědá | 743,60 Kč | m |
|  | PR0020/00 | 6-002542-0000 | Válcovaná schránka, čtvrtkulatá VRB 205, bezbarvá | 807,28 Kč | m |
|  | PR0020/01 | 6-002542-0001 | Válcovaná schránka, čtvrtkulatá VRB 205, bílá | 805,85 Kč | m |
|  | PR0020/03 | 6-002542-0003 | Válcovaná schránka, čtvrtkulatá VRB 205, hnědá | 805,85 Kč | m |
|  | PR0031/00 | 6-001886-0000 | Válcovaná schránka, zaoblená ROS 138 - bezbarvá | 662,55 Kč | m |
|  | PR0031/01 | 6-001886-0001 | Válcovaná schránka, zaoblená ROS 138 - bílá | 671,25 Kč | m |
|  | PR0031/03 | 6-001886-0003 | Válcovaná schránka, zaoblená ROS 138 - hnědá | 949,78 Kč | m |
|  | PR0032/00 | 6-001891-0000 | Válcovaná schránka, zaoblená ROS 165 - bezbarvá | 721,95 Kč | m |
|  | PR0032/01 | 6-001891-0001 | Válcovaná schránka, zaoblená ROS 165 - bílá | 775,40 Kč | m |
|  | PR0032/03 | 6-001891-0003 | Válcovaná schránka, zaoblená ROS 165 - hnědá | 1 017,08 Kč | m |
|  | PR0033/00 | 6-002550-0000 | Válcovaná schránka, zaoblená ROS 180 - bezbarvá | 785,58 Kč | m |
|  | PR0033/01 | 6-002550-0001 | Válcovaná schránka, zaoblená ROS 180 - bílá | 826,13 Kč | m |

















| | | | | | |
|---|-------------|---------------|---|-------------|---|
|  | PR0033/03 | 6-002550-0003 | Válcovaná schránka, zaoblená ROS 180 - hnědá | 1 094,58 Kč | m |
|  | PR0034/00 | 6-002548-0000 | Válcovaná schránka, zaoblená ROS 205 - bezbarvá | 920,08 Kč | m |
|  | PR0034/01 | 6-002548-0001 | Válcovaná schránka, zaoblená ROS 205 - BÍLÁ | 982,98 Kč | m |
|  | PR0034/03 | 6-002548-0003 | Válcovaná schránka, zaoblená ROS 205 - HNĚDÁ | 1 273,08 Kč | m |
|  | PR0039/00 | 6-002534-0000 | Protlačovaná schránka, RR 125 - bezbarvá | 460,40 Kč | m |
|  | PR0039/01 | 6-002534-0001 | Protlačovaná schránka, RR 125 - bílá | 573,68 Kč | m |
|  | PR0039/03 | 6-002534-0003 | Protlačovaná schránka, RR 125 - hnědá | 573,68 Kč | m |
|  | PR0039/2178 | 6-002534-2178 | Protlačovaná schránka, RR 125, DUB ZLATÝ 2178 | 889,38 Kč | m |
|  | PR0039/2179 | 6-002534-2179 | Protlačovaná schránka, RR 125, OŘECH 2179 | 889,38 Kč | m |
|  | PR0040/00 | 6-002531-0000 | Protlačovaná schránka, RR 138 - bezbarvá | 378,63 Kč | m |
|  | PR0040/01 | 6-002531-0001 | Protlačovaná schránka, RR 138 - bílá | 471,73 Kč | m |
|  | PR0040/03 | 6-002531-0003 | Protlačovaná schránka, RR 138 - hnědá | 471,73 Kč | m |
|  | PR0040/2178 | 6-002531-2178 | Protlačovaná schránka, RR 138, DUB ZLATÝ 2178 | 913,40 Kč | m |
|  | PR0040/2179 | 6-002531-2179 | Protlačovaná schránka, RR 138, OŘECH 2179 | 913,40 Kč | m |
|  | PR0042/00 | 6-002525-0000 | Protlačovaná schránka, RR 165 - bezbarvá | 616,40 Kč | m |
|  | PR0042/01 | 6-002525-0001 | Protlačovaná schránka, RR 165 - bílá | 668,00 Kč | m |











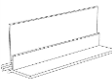

| | | | | | |
|---|-------------|---------------|---|-----------|---|
|  | PR0042/03 | 6-002525-0003 | Protlačovaná schránka, RR 165 - hnědá | 668,00 Kč | m |
|  | PR0049/00 | 6-001684-0000 | Protlačovaná schránka, úkos 20°, RK 125, spodní, bezbarvá | 237,78 Kč | m |
|  | PR0049/01 | 6-001684-0001 | Protlačovaná schránka, úkos 20°, RK 125, spodní, bílá | 301,93 Kč | m |
|  | PR0049/03 | 6-001684-0003 | Protlačovaná schránka, úkos 20°, RK 125, spodní, hnědá | 301,93 Kč | m |
|  | PR0050/00 | 6-001687-0000 | Protlačovaná schránka, úkos 20°, RK 138, spodní, bezbarvá | 279,30 Kč | m |
|  | PR0050/01 | 6-001687-0001 | Protlačovaná schránka, úkos 20°, RK 138, spodní, bílá | 345,95 Kč | m |
|  | PR0050/03 | 6-001687-0003 | Protlačovaná schránka, úkos 20°, RK 138, spodní, hnědá | 345,95 Kč | m |
|  | PR0050/2178 | 6-001687-2178 | Protlačovaná schránka, úkos 20°, RK 138, spodní, zlatý dub 2178 | 714,80 Kč | m |
|  | PR0050/2179 | 6-001687-2179 | Protlačovaná schránka, úkos 20°, RK 138, spodní, ořech 2179 | 841,83 Kč | m |
|  | PR0051/00 | 6-001690-0000 | Protlačovaná schránka, úkos 20°, RK 150, spodní, bezbarvá | 325,83 Kč | m |
|  | PR0051/01 | 6-001690-0001 | Protlačovaná schránka, úkos 20°, RK 150, spodní, bílá | 406,33 Kč | m |
|  | PR0051/03 | 6-001690-0003 | Protlačovaná schránka, úkos 20°, RK 150, spodní, hnědá | 406,33 Kč | m |
|  | PR0051/2178 | 6-001690-2178 | Protlačovaná schránka, úkos 20°, RK 150, spodní, Zlatý dub 2178 | 752,28 Kč | m |
|  | PR0051/2179 | 6-001690-2179 | Protlačovaná schránka, úkos 20°, RK 150, spodní, Ořech 2179 | 815,90 Kč | m |
|  | PR0052/00 | 6-001693-0000 | Protlačovaná schránka, úkos 20°, RK 165, spodní, bezbarvá | 430,23 Kč | m |
|  | PR0052/01 | 6-001693-0001 | Protlačovaná schránka, úkos 20°, RK 165, spodní, bílá | 437,78 Kč | m |

| | | | | | |
|---|-------------|----------------|---|-----------|----|
|  | PR0052/03 | 6-001693-0003 | Protlačovaná schránka, úkos 20°, RK 165, spodní, hnědá | 437,78 Kč | m |
|  | PR0052/2178 | 6-001693-2178 | Protlačovaná schránka, úkos 20°, RK 165, spodní, Zlatý dub 2178 | 822,70 Kč | m |
|  | PR0052/2179 | 6-001693-2179 | Protlačovaná schránka, úkos 20°, RK 165, spodní, Ořech 2179 | 892,63 Kč | m |
|  | PR0053/00 | 6-001695-0000 | Protlačovaná schránka, úkos 20°, RK 180, spodní, bezbarvá | 406,33 Kč | m |
|  | PR0053/01 | 6-001695-0001 | Protlačovaná schránka, úkos 20°, RK 180, spodní, bílá | 490,58 Kč | m |
|  | PR0053/03 | 6-001695-0003 | Protlačovaná schránka, úkos 20°, RK 180, spodní, hnědá | 490,58 Kč | m |
|  | PR0053/2178 | 6-001695-2178 | Protlačovaná schránka, úkos 20°, RK 180, spodní, Zlatý dub 2178 | 866,73 Kč | m |
|  | PR0053/2179 | 6-001695-2179 | Protlačovaná schránka, úkos 20°, RK 180, spodní, Ořech 2179 | 942,23 Kč | m |
|  | PR0059/00-2 | 6-001755-00002 | Bočnice, 20°, BKS-N 125 -PÁR | 196,88 Kč | ks |
|  | PR0059/01-2 | 6-001755-00012 | Bočnice, 20°, BKS-N 125 -PÁR | 219,53 Kč | ks |
|  | PR0059/03-2 | 6-001755-00032 | Bočnice, 20°, BKS-N 125 -PÁR | 219,53 Kč | ks |
|  | PR0060/00-2 | 6-001756-00002 | Bočnice, 20°, BKS-N 138 -PÁR | 218,90 Kč | ks |
|  | PR0060/01-2 | 6-001756-00012 | Bočnice, 20°, BKS-N 138 -PÁR | 234,60 Kč | ks |
|  | PR0060/03-2 | 6-001756-00032 | Bočnice, 20°, BKS-N 138 -PÁR | 234,60 Kč | ks |
|  | PR0061/00-2 | 6-001759-00002 | Bočnice, 20°, BKS-N 150 -PÁR | 235,90 Kč | ks |
|  | PR0061/01-2 | 6-001759-00012 | Bočnice, 20°, BKS-N 150 -PÁR | 261,68 Kč | ks |

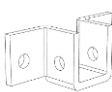
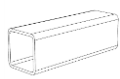

| | | | | | |
|---|-------------|----------------|---------------------------------|-----------|----|
|  | PR0061/03-2 | 6-001759-00032 | Bočnice, 20°, BKS-N 150 -PÁR | 261,68 Kč | ks |
|  | PR0062/00-2 | 6-001762-00002 | Bočnice, 20°, BKS-N 165 -PÁR | 254,78 Kč | ks |
|  | PR0062/01-2 | 6-001762-00012 | Bočnice, 20°, BKS-N 165 -PÁR | 280,55 Kč | ks |
|  | PR0062/03-2 | 6-001762-00032 | Bočnice, 20°, BKS-N 165 -PÁR | 280,55 Kč | ks |
|  | PR0063/00-2 | 6-001766-00002 | Bočnice, 20°, BKS-N 180 -PÁR | 286,20 Kč | ks |
|  | PR0063/01-2 | 6-001766-00012 | Bočnice, 20°, BKS-N 180 -PÁR | 318,28 Kč | ks |
|  | PR0063/03-2 | 6-001766-00032 | Bočnice, 20°, BKS-N 180 -PÁR | 318,28 Kč | ks |
|  | PR0064/00-2 | 6-001768-00002 | Bočnice, 20°, BKS-N 205 -PÁR | 420,28 Kč | ks |
|  | PR0064/01-2 | 6-001768-00012 | Bočnice, 20°, BKS-N 205 -PÁR | 428,95 Kč | ks |
|  | PR0064/03-2 | 6-001768-00032 | Bočnice, 20°, BKS-N 205 -PÁR | 428,95 Kč | ks |
|  | PR0065/00-2 | 6-001884-00002 | Bočnice, kulatá, BKR-N 138 -PÁR | 243,45 Kč | ks |
|  | PR0065/01-2 | 6-001884-00012 | Bočnice, kulatá, BKR-N 138 -PÁR | 283,05 Kč | ks |
|  | PR0065/03-2 | 6-001884-00032 | Bočnice, kulatá, BKR-N 138 -PÁR | 283,05 Kč | ks |
|  | PR0066/00-2 | 6-001889-00002 | Bočnice, kulatá, BKR-N 165 -PÁR | 309,45 Kč | ks |
|  | PR0066/01-2 | 6-001889-00012 | Bočnice, kulatá, BKR-N 165 -PÁR | 343,45 Kč | ks |
|  | PR0066/03-2 | 6-001889-00032 | Bočnice, kulatá, BKR-N 165 -PÁR | 343,45 Kč | ks |



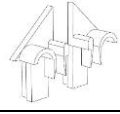
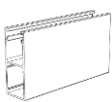

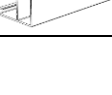

| | | | | | |
|---|-------------|----------------|---------------------------------------|-----------|----|
|  | PR0067/00-2 | 6-002385-00002 | Bočnice, kulatá, BKR-N 180 -PÁR | 398,80 Kč | ks |
|  | PR0067/01-2 | 6-002385-00012 | Bočnice, kulatá, BKR-N 180 -PÁR | 452,85 Kč | ks |
|  | PR0067/03-2 | 6-002385-00032 | Bočnice, kulatá, BKR-N 180 -PÁR | 452,85 Kč | ks |
|  | PR0068/00-2 | 6-001896-00002 | Bočnice, kulatá, BKR-N 205 -PÁR | 504,88 Kč | ks |
|  | PR0068/01-2 | 6-001896-00012 | Bočnice, kulatá, BKR-N 205 -PÁR | 586,73 Kč | ks |
|  | PR0068/03-2 | 6-001896-00032 | Bočnice, kulatá, BKR-N 205 -PÁR | 586,73 Kč | ks |
|  | PR0069/00-2 | 6-001885-00002 | Bočnice, čtvrtkulatá, BKVR-N 138 -PÁR | 500,05 Kč | ks |
|  | PR0069/01-2 | 6-001885-00012 | Bočnice, čtvrtkulatá, BKVR-N 138 -PÁR | 491,83 Kč | ks |
|  | PR0069/03-2 | 6-001885-00032 | Bočnice, čtvrtkulatá, BKVR-N 138 -PÁR | 491,83 Kč | ks |
|  | PR0070/00-2 | 6-001890-00002 | Bočnice, čtvrtkulatá, BKVR-N 165 -PÁR | 552,90 Kč | ks |
|  | PR0070/01-2 | 6-001890-00012 | Bočnice, čtvrtkulatá, BKVR-N 165 -PÁR | 581,83 Kč | ks |
|  | PR0070/03-2 | 6-001890-00032 | Bočnice, čtvrtkulatá, BKVR-N 165 -PÁR | 581,83 Kč | ks |
|  | PR0071/00-2 | 6-001894-00002 | Bočnice, čtvrtkulatá, BKVR-N 180 -PÁR | 679,30 Kč | ks |
|  | PR0071/01-2 | 6-001894-00012 | Bočnice, čtvrtkulatá, BKVR-N 180 -PÁR | 708,88 Kč | ks |
|  | PR0071/03-2 | 6-001894-00032 | Bočnice, čtvrtkulatá, BKVR-N 180 -PÁR | 708,88 Kč | ks |
|  | PR0072/00-2 | 6-002391-00002 | Bočnice, čtvrtkulatá, BKVR-N 205 -PÁR | 844,10 Kč | ks |









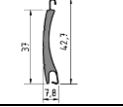
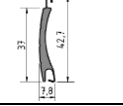
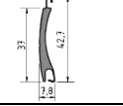
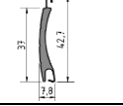
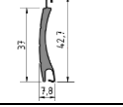
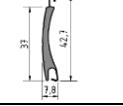
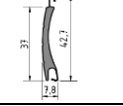
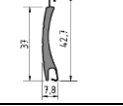
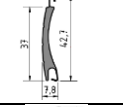
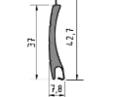



| | | | | | |
|---|-------------|----------------|---|-----------|----|
|  | PR0072/01-2 | 6-002391-00012 | Bočnice, čtvrtkulatá, BKVR-N 205 -PÁR | 852,90 Kč | ks |
|  | PR0072/03-2 | 6-002391-00032 | Bočnice, čtvrtkulatá, BKVR-N 205 -PÁR | 852,90 Kč | ks |
|  | PR0073/00-2 | 6-001928-00002 | Bočnice, proti hmyzu, 20°, BKS-I-N 138 -PÁR | 243,45 Kč | ks |
|  | PR0073/01-2 | 6-001928-00012 | Bočnice, proti hmyzu, 20°, BKS-I-N 138 -PÁR | 280,55 Kč | ks |
|  | PR0073/03-2 | 6-001928-00032 | Bočnice, proti hmyzu, 20°, BKS-I-N 138 -PÁR | 280,55 Kč | ks |
|  | PR0074/00-2 | 6-001930-00002 | Bočnice, proti hmyzu, 20°, BKS-I-N 150 -PÁR | 281,18 Kč | ks |
|  | PR0074/01-2 | 6-001930-00012 | Bočnice, proti hmyzu, 20°, BKS-I-N 150 -PÁR | 312,00 Kč | ks |
|  | PR0074/03-2 | 6-001930-00032 | Bočnice, proti hmyzu, 20°, BKS-I-N 150 -PÁR | 312,00 Kč | ks |
|  | PR0075/00-2 | 6-001932-00002 | Bočnice, proti hmyzu, 20°, BKS-I-N 165 -PÁR | 295,00 Kč | ks |
|  | PR0075/01-2 | 6-001932-00012 | Bočnice, proti hmyzu, 20°, BKS-I-N 165 -PÁR | 335,90 Kč | ks |
|  | PR0075/03-2 | 6-001932-00032 | Bočnice, proti hmyzu, 20°, BKS-I-N 165 -PÁR | 335,90 Kč | ks |
|  | PR0076/00-2 | 6-001933-00002 | Bočnice, proti hmyzu, 20°, BKS-I-N 180 -PÁR | 333,98 Kč | ks |
|  | PR0076/01-2 | 6-001933-00012 | Bočnice, proti hmyzu, 20°, BKS-I-N 180 -PÁR | 370,48 Kč | ks |
|  | PR0076/03-2 | 6-001933-00032 | Bočnice, proti hmyzu, 20°, BKS-I-N 180 -PÁR | 370,48 Kč | ks |
|  | PR0077/00 | 6-001852-0000 | Omitací lišta PS-V 20°, bezbarvá | 201,30 Kč | m |
|  | PR0077/01 | 6-001852-0001 | Omitací lišta PS-V 20°, bílá | 301,93 Kč | m |



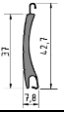
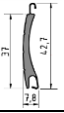
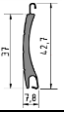







| | | | | | |
|---|-------------|----------------|---|-------------|----|
|  | PR0077/03 | 6-001852-0003 | Omitací lišta PS-V 20°, hnědá | 301,93 Kč | m |
|  | PR0077/2178 | 6-001852-2178 | Omitací lišta PS-V 20°, zlatý dub 2178 | 522,03 Kč | m |
|  | PR0077/2179 | 6-001852-2179 | Omitací lišta PS-V 20°, ořech 2179 | 522,03 Kč | m |
|  | PR0084 | 6-001775-0000 | Vymez. podložka, zaobl. AWBR 138/40 | 118,25 Kč | ks |
|  | PR0092/10 | 6-002684-0000 | Pružina OCTO 40 - 600mm | 1 899,53 Kč | ks |
|  | PR0092/17 | 6-002686-0000 | Pružina OCTO 40 - 715mm | 2 201,45 Kč | ks |
|  | PR0094 | 6-002693-0000 | Držák pružiny MINI pro max. 30 kg | 89,30 Kč | ks |
|  | PR0095 | 6-002694-0000 | Redukce pro VR30 | 31,45 Kč | ks |
|  | PR0096 | 6-002695-0000 | Závlačka | 5,05 Kč | ks |
|  | PR0099 | 6-001873-0000 | Ocelová osmihránná hřidel 40mm-vnější spoj | 130,83 Kč | m |
|  | PR0100 | 6-001875-0000 | Ocelová osmihránná hřidel 60mm | 182,43 Kč | m |
|  | PR0101 | 6-002677-0000 | Závěšovací kroužek pro hřidel 40 | 26,40 Kč | ks |
|  | PR0102 | 6-001871-0000 | Pérová pojistka(závěs s ocelovým páskem), Mini č.1 | 44,03 Kč | ks |
|  | PR0103/0200 | 6-001770-0200 | Náběh pro DF A 3 -PÁR | 47,03 Kč | ks |
|  | PR0105/0200 | 6-002460-0200 | Náběh pro DF A 5 -PÁR | 81,75 Kč | ks |
|  | PR0109/00 | 7-302261-00001 | Vodicí lišta A3 BEZBARVÁ | 273,00 Kč | m |



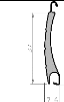

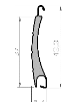
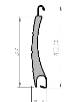
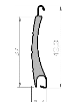
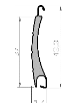



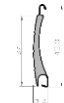
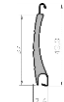







| | | | | | |
|---|-------------|---------------|---|-------------|---|
|  | PR0109/01 | 6-001786-0001 | Vodící lišta A3 BÍLÁ 01 | 368,60 Kč | m |
|  | PR0109/03 | 6-001786-0003 | Vodící lišta A3 HNĚDÁ 03 | 368,60 Kč | m |
|  | PR0109/08 | 6-001786-0008 | Vodící lišta A3 STŘÍBRNÁ 08 | 367,35 Kč | m |
|  | PR0109/2178 | 6-001786-2178 | Vodící lišta A3 RENOLIT 2178 | 621,45 Kč | m |
|  | PR0109/2179 | 6-001786-2179 | Vodící lišta A3 RENOLIT 2179 | 621,45 Kč | m |
|  | PR0110/00 | 6-001788-0000 | Vodící lišta A4 BEZBARVÁ | 379,93 Kč | m |
|  | PR0110/01 | 6-001788-0001 | Vodící lišta A4 BÍLÁ 01 | 561,10 Kč | m |
|  | PR0110/03 | 6-001788-0003 | Vodící lišta A4 HNĚDÁ 03 | 593,48 Kč | m |
|  | PR0111/00 | 6-002595-0000 | Vodící lišta A5 BEZBARVÁ | 299,43 Kč | m |
|  | PR0111/01 | 6-002595-0001 | Vodící lišta A5 BÍLÁ 01 | 452,85 Kč | m |
|  | PR0111/03 | 6-002595-0003 | Vodící lišta A5 HNĚDÁ 03 | 452,85 Kč | m |
|  | PR0112/00 | 6-001926-0000 | Vodící lišta A20, se šikmým kartáčkem pro síť, bezbarvá | 647,85 Kč | m |
|  | PR0112/01 | 6-001926-0001 | Vodící lišta A20, se šikmým kartáčkem pro síť, bílá 01 | 808,88 Kč | m |
|  | PR0112/03 | 6-001926-0003 | Vodící lišta A20, se šikmým kartáčkem pro síť, hnědá 03 | 808,88 Kč | m |
|  | PR0112/2178 | 6-001926-2178 | Vodící lišta A20, se šikmým kartáčkem pro síť, renolit zlatý dub 2178 | 1 040,35 Kč | m |
|  | PR0112/2179 | 6-001926-2179 | Vodící lišta A20, se šikmým kartáčkem pro síť, renolit ořech 2179 | 1 040,35 Kč | m |







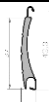
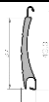
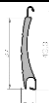

| | | | | | |
|---|-------------|---------------|--|-------------|----|
|  | PR0113/00 | 6-002600-0000 | Vodící lišta A8-20 BEZBARVÁ | 456,65 Kč | m |
|  | PR0113/01 | 6-002600-0001 | Vodící lišta A8-20 BÍLÁ 01 | 662,55 Kč | m |
|  | PR0113/03 | 6-002600-0003 | Vodící lišta A8-20 HNĚDÁ 03 | 662,55 Kč | m |
|  | PR0114/00 | 6-002601-0000 | Vodící lišta DF A3 BEZBARVÁ | 823,20 Kč | m |
|  | PR0114/01 | 6-002601-0001 | Vodící lišta DF A3 BÍLÁ 01 | 1 018,48 Kč | m |
|  | PR0114/03 | 6-002601-0003 | Vodící lišta DF A3 HNĚDÁ 03 | 1 018,48 Kč | m |
|  | PR0114/2178 | 6-002601-2178 | Vodící lišta DF A3 RENOLIT ZLATÝ DUB 2178 | 1 495,85 Kč | m |
|  | PR0114/2179 | 6-002601-2179 | Vodící lišta DF A3 RENOLIT OŘECH 2179 | 1 495,85 Kč | m |
|  | PR0115/00 | 6-001858-0000 | Ukončovací lišta SL DB velká-pro skrytou zarážku, bezbarvá | 217,65 Kč | m |
|  | PR0115/01 | 6-001858-0001 | Ukončovací lišta SL DB velká-pro skrytou zarážku, bílá | 289,33 Kč | m |
|  | PR0115/03 | 6-001858-0003 | Ukončovací lišta SL DB velká-pro skrytou zarážku, hnědá | 273,00 Kč | m |
|  | PR0121 | 6-001866-0000 | Otočná zarážka Poly, transparentní -PÁR | 25,15 Kč | ks |
|  | PR0151 | 6-001939-0000 | | 1 122,10 Kč | m |
|  | PR0152 | 6-001937-0000 | Síť proti hmyzu ISG 600x170cm | 1 270,58 Kč | m |
|  | PR0153 | 6-001938-0000 | Síť proti hmyzu ISG 600x250cm | 1 533,45 Kč | m |
|  | PR0157/00 | 6-001935-0000 | Ukončovací lišta SLI.2 - bez PÚ | 218,90 Kč | m |

| | | | | | |
|---|-------------|---------------|--|-----------|----|
|  | PR0157/01 | 6-001935-0001 | Ukončovací lišta SLI.2 - BÍLÁ | 288,08 Kč | m |
|  | PR0157/03 | 6-001935-0003 | Ukončovací lišta SLI.2 - HNĚDÁ | 309,60 Kč | m |
|  | PR0157/2178 | 6-001935-2178 | Ukončovací lišta SLI.2 - RENOLIT 2178 001 | 493,35 Kč | m |
|  | PR0157/2179 | 6-001935-2179 | Ukončovací lišta SLI.2 - RENOLIT 2179 | 493,35 Kč | m |
|  | PR0158 | 6-001749-0000 | Kartáček pro SL-I 4,8x20mm | 51,58 Kč | m |
|  | PR0162/1 | 6-001942-0000 | SADA dílů Easy-Click pro A 20 | 484,30 Kč | ks |
|  | PR0164/01/B | 6-002608-0101 | Hliník. roletová lamela M 328-bez prosvět. Otvorů, bílá | 59,10 Kč | m |
|  | PR0164/01/S | 6-002607-0201 | Hliníková roletová lamela M 328-s prosvět. Otvory, bílá | 59,10 Kč | m |
|  | PR0164/02/B | 6-002608-0102 | Hliník. roletová lamela M 328-bez prosvět. Otvorů, světle šedá | 59,10 Kč | m |
|  | PR0164/02/S | 6-002607-0202 | Hliníková roletová lamela M 328-s prosvět. Otvory, světle šedá | 59,10 Kč | m |
|  | PR0164/03/B | 6-002608-0103 | Hliník. roletová lamela M 328-bez prosvět. Otvorů, tmavě hnědá | 59,10 Kč | m |
|  | PR0164/03/S | 6-002607-0203 | Hliníková roletová lamela M 328-s prosvět. Otvory, tmavě hnědá | 59,10 Kč | m |
|  | PR0164/04/B | 6-002608-0104 | Hliník. roletová lamela M 328-bez prosvět. Otvorů, světle béžová | 62,90 Kč | m |
|  | PR0164/04/S | 6-002607-0204 | Hliníková roletová lamela M 328-s prosvět. Otvory, světle béžová | 59,10 Kč | m |
|  | PR0164/07/B | 6-002608-0107 | Hliník. roletová lamela M 328-bez prosvět. Otvorů, přírodní | 59,10 Kč | m |
|  | PR0164/07/S | 6-002607-0207 | Hliníková roletová lamela M 328-s prosvět. Otvory, přírodní | 59,10 Kč | m |





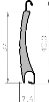
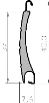
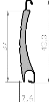
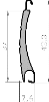
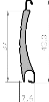







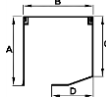
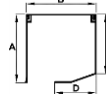
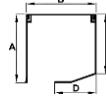

| | | | | | |
|---|-------------|---------------|--|----------|---|
|  | PR0164/13/B | 6-002608-0113 | Hliník. roletová lamela M 328-bez prosvět. Otvorů, mechově zelená | 62,90 Kč | m |
|  | PR0164/13/S | 6-002607-0213 | Hliníková roletová lamela M 328-s prosvět. Otvory, mechově zelená | 62,90 Kč | m |
|  | PR0164/22/B | 6-002608-0122 | Hliník. roletová lamela M 328-bez prosvět. otvorů | 66,68 Kč | m |
|  | PR0164/22/S | 6-002607-0222 | Hliníková roletová lamela M 328-s prosvět. otvory | 66,68 Kč | m |
|  | PR0164/27/B | 6-002608-0127 | Hliník. roletová lamela M 328-bez prosvět. Otvorů, krémově bílá | 62,90 Kč | m |
|  | PR0164/27/S | 6-002607-0227 | Hliníková roletová lamela M 328-s prosvět. Otvory, krémově bílá | 62,90 Kč | m |
|  | PR0164/30/B | 6-002608-0130 | Hliník. roletová lamela M 328-bez prosvět. Otvorů, karibik hnědá | 62,90 Kč | m |
|  | PR0164/30/S | 6-002607-0230 | Hliníková roletová lamela M 328-s prosvět. Otvory, karibik hnědá | 59,10 Kč | m |
|  | PR0164/35/B | 6-002608-0135 | Hliník. roletová lamela M 328-bez prosvět. Otvorů, pískově béžová | 62,90 Kč | m |
|  | PR0164/35/S | 6-002607-0235 | Hliníková roletová lamela M 328-s prosvětí.otvory, pískově béžová | 59,10 Kč | m |
|  | PR0164/36/B | 6-002608-0136 | Hliník. roletová lamela M 328-bez prosvět. Otvorů, tele-šedá | 64,15 Kč | m |
|  | PR0164/38/B | 6-002608-0138 | Hliník. roletová lamela M 328-bez prosvět. otvorů | 59,10 Kč | m |
|  | PR0164/38/S | 6-002607-0238 | Hliníková roletová lamela M 328-s prosvět. otvory | 59,10 Kč | m |
|  | PR0164/81/B | 6-002608-0181 | Hliník. roletová lamela M 328-bez prosvět. otvorů | 64,15 Kč | m |
|  | PR0164/81/S | 6-002607-0281 | Hliníková roletová lamela M 328-s prosvět. otvory | 64,15 Kč | m |
|  | PR0164/82/B | 6-002608-0182 | Hliník. roletová lamela M 328-bez prosvět. otvorů | 64,15 Kč | m |





| | | | | | |
|---|-------------|---------------|---|----------|---|
|  | PR0164/82/S | 6-002607-0282 | Hliníková roletová lamela M 328-s prosvětl. otvory | 64,15 Kč | m |
|  | PR0164/84/B | 6-002608-0184 | Hliník. roletová lamela M 328-bez prosvětl. otvorů | 62,90 Kč | m |
|  | PR0164/84/S | 6-002607-0284 | Hliníková roletová lamela M 328-s prosvětl. otvory | 59,10 Kč | m |
|  | PR0164/86/B | 6-002608-0186 | Hliník. roletová lamela M 328-bez prosvětl. Otvorů, ořech | 71,68 Kč | m |
|  | PR0164/86/S | 6-002607-0286 | Hliníková roletová lamela M 328-s prosvětl. Otvory, ořech | 71,68 Kč | m |
|  | PR0165/01/B | 6-002606-0101 | Hliník. roletová lamela M 317-bez prosvětl. Otvorů, bílá | 67,93 Kč | m |
|  | PR0165/01/S | 6-002605-0201 | Hliníková roletová lamela M 317-s prosvětl. Otvory, bílá | 67,93 Kč | m |
|  | PR0165/02/B | 6-002606-0102 | Hliník. roletová lamela M 317-bez prosvětl. Otvorů, světle šedá | 71,68 Kč | m |
|  | PR0165/02/S | 6-002605-0202 | Hliníková roletová lamela M 317-s prosvětl. Otvory, světle šedá | 71,68 Kč | m |
|  | PR0165/03/B | 6-002606-0103 | Hliník. roletová lamela M 317-bez prosvětl. Otvorů, tmavě hnědá | 67,93 Kč | m |
|  | PR0165/03/S | 6-002605-0203 | Hliníková roletová lamela M 317-s prosvětl. Otvory, tmavě hnědá | 67,93 Kč | m |
|  | PR0165/04/B | 6-002606-0104 | Hliník. roletová lamela M 317-bez prosvětl. Otvorů, světle béžová | 71,68 Kč | m |
|  | PR0165/04/S | 6-002605-0204 | Hliníková roletová lamela M 317-s prosvětl. Otvory, světle béžová | 71,68 Kč | m |
|  | PR0165/05/B | 6-002606-0105 | Hliník. roletová lamela M 317-bez prosvětl. Otvorů, tmavě béžová | 85,55 Kč | m |
|  | PR0165/05/S | 6-002605-0205 | Hliníková roletová lamela M 317-s prosvětl. Otvory, tmavě béžová | 85,55 Kč | m |
|  | PR0165/07/B | 6-002606-0107 | Hliník. roletová lamela M 317-bez prosvětl. Otvorů, přírodní | 67,93 Kč | m |







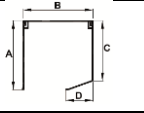
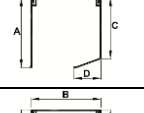
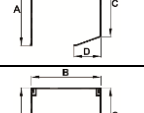
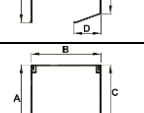
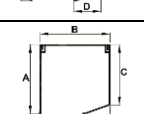
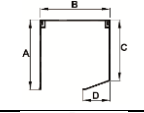
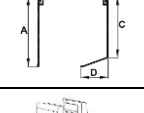
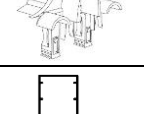
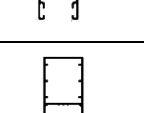
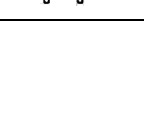
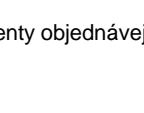

| | | | | | |
|---|-------------|---------------|---|----------|---|
|  | PR0165/07/S | 6-002605-0207 | Hliníková roletová lamela M 317-s prosvětl. Otvory, přírodní | 67,93 Kč | m |
|  | PR0165/09/B | 6-002606-0109 | Hliník. roletová lamela M 317-bez prosvětl. Otvorů, bronzová | 85,55 Kč | m |
|  | PR0165/09/S | 6-002605-0209 | Hliníková roletová lamela M 317-s prosvětl. Otvory, bronzová | 88,05 Kč | m |
|  | PR0165/11/B | 6-002606-0111 | Hliník. roletová lamela M 317-bez prosvětl. Otvorů, dřevo dub | 72,98 Kč | m |
|  | PR0165/11/S | 6-002605-0211 | Hliníková roletová lamela M 317-s prosvětl. Otvory, dřevo dub | 72,98 Kč | m |
|  | PR0165/12/B | 6-002606-0112 | Hliník. roletová lamela M 317-bez prosvětl. Otvorů, dřevo teak | 72,98 Kč | m |
|  | PR0165/12/S | 6-002605-0212 | Hliníková roletová lamela M 317-s prosvětl. Otvory, dřevo teak | 72,98 Kč | m |
|  | PR0165/13/B | 6-002606-0113 | Hliník. roletová lamela M 317-bez prosvětl. Otvorů, mechově zelená | 71,68 Kč | m |
|  | PR0165/13/S | 6-002605-0213 | Hliníková roletová lamela M 317-s prosvětl. Otvory, mechově zelená | 71,68 Kč | m |
|  | PR0165/14/B | 6-002606-0114 | Hliník. roletová lamela M 317-bez prosvětl. otvorů | 85,55 Kč | m |
|  | PR0165/14/S | 6-002605-0214 | Hliníková roletová lamela M 317-s prosvětl. otvory | 85,55 Kč | m |
|  | PR0165/22/B | 6-002606-0122 | Hliník. roletová lamela M 317-bez prosvětl. otvorů | 75,48 Kč | m |
|  | PR0165/22/S | 6-002605-0222 | Hliníková roletová lamela M 317-s prosvětl. otvory | 75,48 Kč | m |
|  | PR0165/23/B | 6-002606-0123 | Hliník. roletová lamela M 317-bez prosvětl. Otvorů, světlejší šedá | 71,68 Kč | m |
|  | PR0165/23/S | 6-002605-0223 | Hliníková roletová lamela M 317-s prosvětl. Otvory, světlejší šedá | 71,68 Kč | m |
|  | PR0165/27/B | 6-002606-0127 | Hliník. roletová lamela M 317-bez prosvětl. Otvorů, krémově bílá | 71,68 Kč | m |

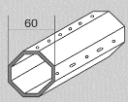















| | | | | | |
|---|-------------|---------------|--|-----------|---|
|  | PR0165/27/S | 6-002605-0227 | Hliníková roletová lamela M 317-s prosvět. Otvory, krémově bílá | 71,68 Kč | m |
|  | PR0165/28/B | 6-002606-0128 | Hliník. roletová lamela M 317-bez prosvět. otvorů | 85,55 Kč | m |
|  | PR0165/28/S | 6-002605-0228 | Hliníková roletová lamela M 317-s prosvět. otvory | 85,55 Kč | m |
|  | PR0165/37/B | 6-002606-0137 | Hliník. roletová lamela M 317-bez prosvět. Otvorů, quarz-šedá | 71,68 Kč | m |
|  | PR0165/37/S | 6-002605-0237 | Hliníková roletová lamela M 317-s prosvět. Otvory, quarz-šedá | 92,65 Kč | m |
|  | PR0165/38/B | 6-002606-0138 | Hliník. roletová lamela M 317-bez prosvět. Otvorů, antrazit šedá | 67,93 Kč | m |
|  | PR0165/38/S | 6-002605-0238 | Hliníková roletová lamela M 317-s prosvět. Otvory, antrazit šedá | 67,93 Kč | m |
|  | PR0165/39/B | 6-002606-0139 | Hliník. roletová lamela M 317-bez prosvět. otvorů | 85,55 Kč | m |
|  | PR0165/39/S | 6-002605-0239 | Hliníková roletová lamela M 317-s prosvět. otvory | 85,55 Kč | m |
|  | PR0165/84/B | 6-002606-0184 | Hliník. roletová lamela M 317-bez prosvět. otvorů | 71,68 Kč | m |
|  | PR0165/84/S | 6-002605-0284 | Hliníková roletová lamela M 317-s prosvět. otvory | 71,68 Kč | m |
|  | PR0165/85/B | 6-002606-0185 | Hliník. roletová lamela M 317-bez prosvět. Otvorů, šedý hliník 9007 | 71,68 Kč | m |
|  | PR0165/85/S | 6-002605-0285 | Hliníková roletová lamela M 317-s prosvět. Otvory, šedý hliník 9007 | 71,68 Kč | m |
|  | PR0165/87/B | 6-002606-0187 | Hliník. roletová lamela M 317-bez prosvět. Otvorů, imitace nerez 87 | 109,43 Kč | m |
|  | PR0165/87/S | 6-002605-0287 | Hliníková roletová lamela M 317-s prosvět. Otvory, imitace nerez 87 | 109,43 Kč | m |
|  | PR0167/01/B | 6-001843-0101 | Plast. roletová lamela RM 37-bez prosvět. Otvorů, bílá | 45,78 Kč | m |















| | | | | | |
|---|-------------|----------------|---|-------------|----|
|  | PR0167/01/S | 6-001845-0201 | Plastová roletová lamela RM 37-s prosvět. Otvory, bílá | 45,78 Kč | m |
|  | PR0168/1 | 3-02239-0000 | Aretační klips | 2,23 Kč | ks |
|  | PR0169 | 6-001842-0000 | Aretační klipsy A 442 | 4,50 Kč | ks |
|  | PR0170/00 | 6-001794-0000 | Vodicí lišta A15 BEZBARVÁ | 471,73 Kč | m |
|  | PR0170/01 | 6-001794-0001 | Vodicí lišta A15 BÍLÁ 01 | 676,80 Kč | m |
|  | PR0170/03 | 6-001794-0003 | Vodicí lišta A15 HNĚDÁ 03 | 744,73 Kč | m |
|  | PR0175 | 6-001897-0000 | Řemenice pro oblast MINI - GSV 115 | 85,55 Kč | ks |
|  | PR0175-2 | 6-001897-00002 | Řemenice pro oblast MINI - GSV 109 | 85,55 Kč | ks |
|  | PR0176 | 6-001898-0000 | Řemenice pro oblast MINI - GSV 125 | 89,30 Kč | ks |
|  | PR0177 | 6-001899-0000 | Řemenice pro oblast MINI - GSV 135 | 93,08 Kč | ks |
|  | PR0178 | 6-001900-0000 | Řemenice pro oblast MINI - GSV 155 | 115,70 Kč | ks |
|  | PR0179 | 6-001901-0000 | Řemenice pro oblast MINI - GSV 170 | 114,45 Kč | ks |
|  | PR0180 | 6-002704-0000 | Tyč s klíkou bílá - 120cm | 2 168,75 Kč | ks |
|  | PR0181 | 6-001883-0000 | Tyč s klíkou bílá - 130cm | 2 263,08 Kč | ks |
|  | PR0182 | 6-002706-0000 | Tyč s klíkou bílá - 140cm | 2 241,68 Kč | ks |
|  | PR0183 | 6-002707-0000 | Tyč s klíkou bílá - 150cm | 2 280,70 Kč | ks |





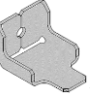











| | | | | | |
|---|-------------|---------------|---|-------------|----|
|  | PR0184 | 6-002708-0000 | Tyč s klikou bílá - 160cm | 2 319,70 Kč | ks |
|  | PR0188/00 | 6-002599-0000 | Vodící lišta A 8-12 BEZBARVÁ | 379,93 Kč | m |
|  | PR0188/01 | 6-002599-0001 | Vodící lišta A8-12 BÍLÁ 01 | 561,30 Kč | m |
|  | PR0188/03 | 6-002599-0003 | Vodící lišta A8-12 HNĚDÁ 03 | 558,55 Kč | m |
|  | PR0192/00 | 6-008229-0000 | Protlačovaná schránka, úkos 20°, RK 205, spodní, bezbarvá | 614,88 Kč | m |
|  | PR0192/01 | 6-008229-0001 | Protlačovaná schránka, úkos 20°, RK 205, spodní, bílá | 705,75 Kč | m |
|  | PR0192/03 | 6-008229-0003 | Protlačovaná schránka, úkos 20°, RK 205, spodní, hnědá | 705,75 Kč | m |
|  | PR0193/01/S | 6-008231-0201 | Hliníková roletová lamela MY 442-s prosvětl. otv., bílá | 116,13 Kč | m |
|  | PR0193/02/S | 6-008231-0202 | Hliníková roletová lamela MY 442-s prosvětl. otv., světle šedá | 116,13 Kč | m |
|  | PR0193/03/S | 6-008231-0203 | Hliníková roletová lamela MY 442-s prosvětl. otv., tmavě hnědá | 116,13 Kč | m |
|  | PR0193/04/S | 6-008231-0204 | Hliníková roletová lamela MY 442-s prosvětl. otv., světle béžová | 116,13 Kč | m |
|  | PR0193/07/S | 6-008231-0207 | Hliníková roletová lamela MY 442-s prosvětl. otv., přírodní | 116,13 Kč | m |
|  | PR0193/13/S | 6-008231-0213 | Hliníková roletová lamela MY 442-s prosvětl. otv., mechově zelená | 135,75 Kč | m |
|  | PR0193/22/S | 6-008231-0222 | Hliníková roletová lamela MY 442-s prosvětl. otv. | 117,73 Kč | m |
|  | PR0193/23/S | 6-008231-0223 | Hliníková roletová lamela MY 442-s prosvětl. otv., světlejší šedá | 116,13 Kč | m |
|  | PR0193/27/S | 6-008231-0227 | Hliníková roletová lamela MY 442-s prosvětl. otv., krémově bílá | 116,13 Kč | m |



| | | | | | |
|---|-------------|---------------|---|-------------|----|
|  | PR0193/30/S | 6-008231-0230 | Hliníková roletová lamela MY 442-s prosvětł. otv., karibik hnědá | 134,10 Kč | m |
|  | PR0193/35/S | 6-008231-0235 | Hliníková roletová lamela MY 442-s prosvětł. otv., pískové béžová | 134,10 Kč | m |
|  | PR0193/38/S | 6-008231-0238 | Hliníková roletová lamela MY 442-s prosvětł. otv., antrazit šedá | 116,13 Kč | m |
|  | PR0193/84/S | 6-008231-0284 | Hliníková roletová lamela MY 442-s prosvětł. otv. | 116,13 Kč | m |
|  | PR0193/86/S | 6-008231-0286 | Hliníková roletová lamela MY 442-s prosvětł. otv., ořech | 127,58 Kč | m |
|  | PR0201/00 | 6-002537-0000 | Protlačová schránka, RR 100, bezbarvá | 356,03 Kč | m |
|  | PR0201/01 | 6-002537-0001 | Protlačová schránka, RR 100, bílá | 465,43 Kč | m |
|  | PR0201/03 | 6-002537-0003 | Protlačová schránka, RR 100, hnědá | 465,43 Kč | m |
|  | PR0201/2178 | 6-002537-2178 | Protlačová schránka, RR 100,DUB ZLATÝ 2178 | 895,68 Kč | m |
|  | PR0201/2179 | 6-002537-2179 | Protlačová schránka, RR 100,OŘECH 2179 | 895,68 Kč | m |
|  | PR0202/00 | 6-010131-0000 | Protlačová schránka, RR 90, bezbarvá | 334,25 Kč | m |
|  | PR0202/01 | 6-010131-0001 | Protlačová schránka, RR 90, bílá | 442,65 Kč | m |
|  | PR0202/03 | 6-010131-0003 | Protlačová schránka, RR 90, hnědá | 442,65 Kč | m |
|  | PR0204/0200 | 6-001783-0200 | Náběh A 5 / A 6 pro vymeřovací podložku - PÁR | 33,33 Kč | ks |
|  | PR0205/00 | 6-001808-0000 | Vodící lišta DF A5 BEZBARVÁ | 636,58 Kč | m |
|  | PR0205/01 | 6-001808-0001 | Vodící lišta DF A5 BÍLÁ 01 | 1 020,23 Kč | m |





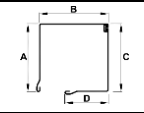
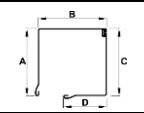
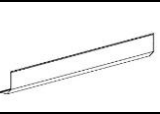
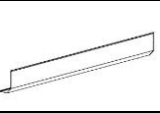
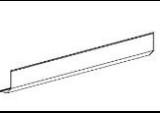
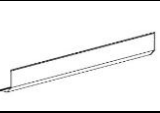
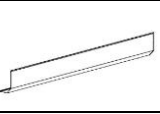
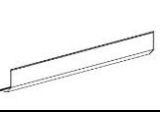
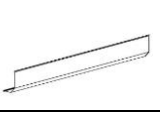
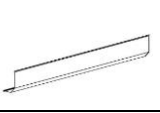
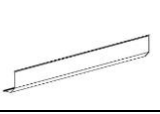
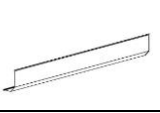
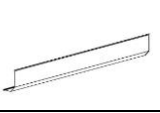
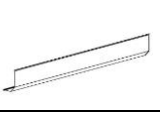
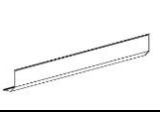

| | | | | | |
|---|-------------|----------------|-------------------------------------|-------------|----|
|  | PR0205/03 | 6-001808-0003 | Vodící lišta DF A5 HNĚDÁ 03 | 1 020,23 Kč | m |
|  | PR0206 | 6-001878-0060 | Hřídel teleskopická pro 60 hřídel | 148,45 Kč | ks |
| | PR0207/01 | 6-002131-0001 | Zámek cylindrový do KL kulatý BÍLÝ | 1 426,53 Kč | ks |
| | PR0207/02 | 6-002131-0002 | Zámek cylindrový do KL kulatý HNĚDÝ | 1 426,53 Kč | ks |
| | PR0207/13 | 6-002131-0013 | Zámek cylindrový do KL kulatý ŠEDÝ | 1 339,85 Kč | ks |
| | PR0208/01 | 6-002133-0001 | Kryt zámku pro KL kulatý BÍLÝ | 174,85 Kč | ks |
| | PR0208/02 | 6-002133-0002 | Kryt zámku pro KL kulatý HNĚDÝ | 174,85 Kč | ks |
| | PR0208/13 | 6-002133-0013 | Kryt zámku pro KL kulatý ŠEDÝ | 166,03 Kč | ks |
|  | PR0210/00-2 | 6-002369-00002 | Bočnice, 45°, BKS-N 125 -PÁR | 228,98 Kč | ks |
|  | PR0210/01-2 | 6-002369-00012 | Bočnice, 45°, BKS-N 125 -PÁR | 257,90 Kč | ks |
|  | PR0210/03-2 | 6-002369-00032 | Bočnice, 45°, BKS-N 125 -PÁR | 257,90 Kč | ks |
|  | PR0211/00-2 | 6-002370-00002 | Bočnice, 45°, BKS-N 138 -PÁR | 201,30 Kč | ks |
|  | PR0211/01-2 | 6-002370-00012 | Bočnice, 45°, BKS-N 138 -PÁR | 221,40 Kč | ks |
|  | PR0211/03-2 | 6-002370-00032 | Bočnice, 45°, BKS-N 138 -PÁR | 221,40 Kč | ks |
|  | PR0212/00-2 | 6-002372-00002 | Bočnice, 45°, BKS-N 165 -PÁR | 254,78 Kč | ks |
|  | PR0212/01-2 | 6-002372-00012 | Bočnice, 45°, BKS-N 165 -PÁR | 280,55 Kč | ks |

| | | | | | |
|---|-------------|----------------|------------------------------|-----------|----|
|  | PR0212/03-2 | 6-002372-00032 | Bočnice, 45°, BKS-N 165 -PÁR | 280,55 Kč | ks |
|  | PR0213/00-2 | 6-002373-00002 | Bočnice, 45°, BKS-N 180 -PÁR | 272,35 Kč | ks |
|  | PR0213/01-2 | 6-002373-00012 | Bočnice, 45°, BKS-N 180 -PÁR | 300,68 Kč | ks |
|  | PR0213/03-2 | 6-002373-00032 | Bočnice, 45°, BKS-N 180 -PÁR | 300,68 Kč | ks |
|  | PR0214/00-2 | 6-002374-00002 | Bočnice, 45°, BKS-N 205 -PÁR | 450,35 Kč | ks |
|  | PR0214/01-2 | 6-002374-00012 | Bočnice, 45°, BKS-N 205 -PÁR | 503,18 Kč | ks |
|  | PR0214/03-2 | 6-002374-00032 | Bočnice, 45°, BKS-N 205 -PÁR | 503,18 Kč | ks |
|  | PR0215/00-2 | 6-002378-00002 | Bočnice, 90°, BK-N 125 -PÁR | 276,38 Kč | ks |
|  | PR0215/01-2 | 6-002378-00012 | Bočnice, 90°, BK-N 125 -PÁR | 306,05 Kč | ks |
|  | PR0215/03-2 | 6-002378-00032 | Bočnice, 90°, BK-N 125 -PÁR | 306,05 Kč | ks |
|  | PR0216/00-2 | 6-002379-00002 | Bočnice, 90°, BK-N 150 -PÁR | 309,45 Kč | ks |
|  | PR0216/01-2 | 6-002379-00012 | Bočnice, 90°, BK-N 150 -PÁR | 338,40 Kč | ks |
|  | PR0216/03-2 | 6-002379-00032 | Bočnice, 90°, BK-N 150 -PÁR | 338,40 Kč | ks |
|  | PR0217/00-2 | 6-002380-00002 | Bočnice, 90°, BK-N 165 -PÁR | 328,95 Kč | ks |
|  | PR0217/01-2 | 6-002380-00012 | Bočnice, 90°, BK-N 165 -PÁR | 357,28 Kč | ks |
|  | PR0217/03-2 | 6-002380-00032 | Bočnice, 90°, BK-N 165 -PÁR | 357,28 Kč | ks |







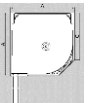
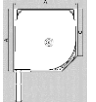
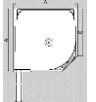
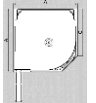
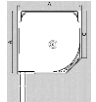

| | | | | | |
|---|-------------|----------------|---|-----------|----|
|  | PR0218/00-2 | 6-002381-00002 | Bočnice, 90°, BK-N 180 -PÁR | 427,70 Kč | ks |
|  | PR0218/01-2 | 6-002381-00012 | Bočnice, 90°, BK-N 180 -PÁR | 481,80 Kč | ks |
|  | PR0218/03-2 | 6-002381-00032 | Bočnice, 90°, BK-N 180 -PÁR | 481,80 Kč | ks |
|  | PR0219/00-2 | 6-002382-00002 | Bočnice, 90°, BK-N 205 -PÁR | 490,58 Kč | ks |
|  | PR0219/01-2 | 6-002382-00012 | Bočnice, 90°, BK-N 205 -PÁR | 532,38 Kč | ks |
|  | PR0219/03-2 | 6-002382-00032 | Bočnice, 90°, BK-N 205 -PÁR | 532,38 Kč | ks |
|  | PR0220/00-2 | 6-002388-00002 | Bočnice, čtvrtkulatá, BKVR-N 150 -PÁR | 602,58 Kč | ks |
|  | PR0220/01-2 | 6-002388-00012 | Bočnice, čtvrtkulatá, BKVR-N 150 -PÁR | 628,98 Kč | ks |
|  | PR0220/03-2 | 6-002388-00032 | Bočnice, čtvrtkulatá, BKVR-N 150 -PÁR | 628,98 Kč | ks |
|  | PR0234/00 | 6-002462-0000 | Ukončení vodící lišty z oceli A5, A6, bezbarvá | 280,55 Kč | ks |
|  | PR0234/01 | 6-002462-0001 | Ukončení vodící lišty z oceli A5, A6, bílá | 377,38 Kč | ks |
|  | PR0234/03 | 6-002462-0003 | Ukončení vodící lišty z oceli A5, A6, hnědá | 377,38 Kč | ks |
|  | PR0236/00 | 6-002545-0000 | Válcovaná schránka, čtvrtkulatá VRB 150, bezbarvá | 567,10 Kč | m |
|  | PR0236/01 | 6-002545-0001 | Válcovaná schránka, čtvrtkulatá VRB 150, bílá | 578,68 Kč | m |
|  | PR0236/03 | 6-002545-0003 | Válcovaná schránka, čtvrtkulatá VRB 150, hnědá | 578,68 Kč | m |
|  | PR0238 | 6-002480-0000 | Kuličkové ložisko 12mm, s okrajem | 33,95 Kč | ks |

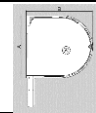
| | | | | | |
|---|-----------|---------------|---|-----------|---|
|  | PR0239/00 | 6-002556-0000 | Válcovaná schránka, úkos 90° GUT 205, bezbarvá | 658,28 Kč | m |
|  | PR0239/01 | 6-002556-0001 | Válcovaná schránka, úkos 90° GUT 205, bílá | 684,33 Kč | m |
|  | PR0239/03 | 6-002556-0003 | Válcovaná schránka, úkos 90° GUT 205, hnědá | 684,33 Kč | m |
|  | PR0240/00 | 6-002557-0000 | Válcovaná schránka, úkos 90° GUT 180, bezbarvá | 541,05 Kč | m |
|  | PR0240/01 | 6-002557-0001 | Válcovaná schránka, úkos 90° GUT 180, bílá | 551,25 Kč | m |
|  | PR0240/03 | 6-002557-0003 | Válcovaná schránka, úkos 90° GUT 180, hnědá | 551,25 Kč | m |
|  | PR0241/00 | 6-002558-0000 | Válcovaná schránka, úkos 90° GUT 165, bezbarvá | 507,85 Kč | m |
|  | PR0241/01 | 6-002558-0001 | Válcovaná schránka, úkos 90° GUT 165, bílá | 516,53 Kč | m |
|  | PR0241/03 | 6-002558-0003 | Válcovaná schránka, úkos 90° GUT 165, hnědá | 516,53 Kč | m |
|  | PR0242/00 | 6-002559-0000 | Válcovaná schránka, úkos 90°, GUT 150, bezbarvá | 457,10 Kč | m |
|  | PR0242/01 | 6-002559-0001 | Válcovaná schránka, úkos 90°, GUT 150, bílá | 467,30 Kč | m |
|  | PR0242/03 | 6-002559-0003 | Válcovaná schránka, úkos 90°, GUT 150, hnědá | 467,30 Kč | m |
|  | PR0243/00 | 6-002560-0000 | Válcovaná schránka, úkos 90°, GUT 138, bezbarvá | 390,58 Kč | m |
|  | PR0243/01 | 6-002560-0001 | Válcovaná schránka, úkos 90°, GUT 138, bílá | 397,93 Kč | m |
|  | PR0243/03 | 6-002560-0003 | Válcovaná schránka, úkos 90°, GUT 138, hnědá | 397,93 Kč | m |
|  | PR0244/00 | 6-002561-0000 | Válcovaná schránka, úkos 90°, GUT 125, bezbarvá | 366,05 Kč | m |

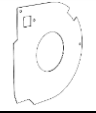
| | | | | | |
|---|-----------|---------------|--|-----------|---|
|  | PR0244/01 | 6-002561-0001 | Válcovaná schránka, úkos 90°, GUT 125, bílá | 383,40 Kč | m |
|  | PR0244/03 | 6-002561-0003 | Válcovaná schránka, úkos 90°, GUT 125, hnědá | 717,03 Kč | m |
|  | PR0245/00 | 6-002565-0000 | Válcovaná schránka, úkos 45° GSUT 205, bezbarvá | 669,60 Kč | m |
|  | PR0245/01 | 6-002565-0001 | Válcovaná schránka, úkos 45° GSUT 205, bílá | 684,33 Kč | m |
|  | PR0245/03 | 6-002565-0003 | Válcovaná schránka, úkos 45° GSUT 205, hnědá | 684,33 Kč | m |
|  | PR0246/00 | 6-002566-0000 | Válcovaná schránka, úkos 45° GSUT 180, bezbarvá | 541,05 Kč | m |
|  | PR0246/01 | 6-002566-0001 | Válcovaná schránka, úkos 45° GSUT 180, bílá | 551,25 Kč | m |
|  | PR0246/03 | 6-002566-0003 | Válcovaná schránka, úkos 45° GSUT 180, hnědá | 551,25 Kč | m |
|  | PR0247/00 | 6-002567-0000 | Válcovaná schránka, úkos 45°, GSUT 165, bezbarvá | 507,85 Kč | m |
|  | PR0247/01 | 6-002567-0001 | Válcovaná schránka, úkos 45°, GSUT 165, bílá | 516,53 Kč | m |
|  | PR0247/03 | 6-002567-0003 | Válcovaná schránka, úkos 45°, GSUT 165, hnědá | 516,53 Kč | m |
|  | PR0248/00 | 6-002568-0000 | Válcovaná schránka, úkos 45°, GSUT 150, bezbarvá | 457,10 Kč | m |
|  | PR0248/01 | 6-002568-0001 | Válcovaná schránka, úkos 45°, GSUT 150, bílá | 467,30 Kč | m |
|  | PR0248/03 | 6-002568-0003 | Válcovaná schránka, úkos 45°, GSUT 150, hnědá | 467,30 Kč | m |
|  | PR0249/00 | 6-002569-0000 | Válcovaná schránka, úkos 45°, GSUT 138, bezbarvá | 390,58 Kč | m |
|  | PR0249/01 | 6-002569-0001 | Válcovaná schránka, úkos 45°, GSUT 138, bílá | 397,93 Kč | m |

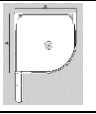
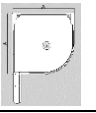
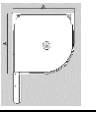
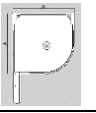
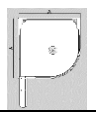
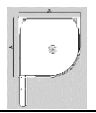
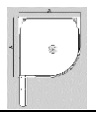















| | | | | | |
|---|-------------|----------------|--|-------------|----|
|  | PR0249/03 | 6-002569-0003 | Válcovaná schránka, úkos 45°, GSUT 138, hnědá | 397,93 Kč | m |
|  | PR0250/00 | 6-002570-0000 | Válcovaná schránka, úkos 45°, GSUT 125, bezbarvá | 366,05 Kč | m |
|  | PR0250/01 | 6-002570-0001 | Válcovaná schránka, úkos 45°, GSUT 125, bílá | 383,40 Kč | m |
|  | PR0250/03 | 6-002570-0003 | Válcovaná schránka, úkos 45°, GSUT 125, hnědá | 657,30 Kč | m |
|  | PR0252/00-2 | 6-002598-00002 | Bočnice, 90°, BK-N 138 -PÁR | 294,38 Kč | ks |
|  | PR0252/01-2 | 6-002598-00012 | Bočnice, 90°, BK-N 138 -PÁR | 315,75 Kč | ks |
|  | PR0252/03-2 | 6-002598-00032 | Bočnice, 90°, BK-N 138 -PÁR | 315,75 Kč | ks |
| | PR0254 | 6-002685-0000 | Západka 10x3 mm do koncové lamely 8 mm | 164,78 Kč | ks |
| | PR0256/2 | 6-012679-0000 | Převodovka 3:1, pro hřídel 40mm L/P IMBUS | 1 835,15 Kč | ks |
|  | PR0262 | 6-002792-0000 | Vymez. podložka, SECTRA, úkos 20°, AWB-I 180/40 | 140,40 Kč | ks |
|  | PR0263/00-2 | 6-002794-00002 | Bočnice, proti hmyzu, 45°, BKS-I-N 138 -PÁR | 280,55 Kč | ks |
|  | PR0263/01-2 | 6-002794-00012 | Bočnice, proti hmyzu, 45°, BKS-I-N 138 -PÁR | 323,33 Kč | ks |
|  | PR0263/03-2 | 6-002794-00032 | Bočnice, proti hmyzu, 45°, BKS-I-N 138 -PÁR | 323,33 Kč | ks |
|  | PR0264/00-2 | 6-002795-00002 | Bočnice, proti hmyzu, 45°, BKS-I-N 150 -PÁR | 323,33 Kč | ks |
|  | PR0264/01-2 | 6-002795-00012 | Bočnice, proti hmyzu, 45°, BKS-I-N 150 -PÁR | 358,80 Kč | ks |
|  | PR0264/03-2 | 6-002795-00032 | Bočnice, proti hmyzu, 45°, BKS-I-N 150 -PÁR | 358,80 Kč | ks |











| | | | | | |
|---|-------------|----------------|---|-----------|----|
|  | PR0265/00-2 | 6-002798-00002 | Bočnice, proti hmyzu, 45°, BKS-I-N 165 -PÁR | 339,65 Kč | ks |
|  | PR0265/01-2 | 6-002798-00012 | Bočnice, proti hmyzu, 45°, BKS-I-N 165 -PÁR | 387,45 Kč | ks |
|  | PR0265/03-2 | 6-002798-00032 | Bočnice, proti hmyzu, 45°, BKS-I-N 165 -PÁR | 387,45 Kč | ks |
|  | PR0266/00-2 | 6-002799-00002 | Bočnice, proti hmyzu, 45°, BKS-I-N 180 -PÁR | 384,93 Kč | ks |
|  | PR0266/01-2 | 6-002799-00012 | Bočnice, proti hmyzu, 45°, BKS-I-N 180 -PÁR | 426,45 Kč | ks |
|  | PR0266/03-2 | 6-002799-00032 | Bočnice, proti hmyzu, 45°, BKS-I-N 180 -PÁR | 426,45 Kč | ks |
|  | PR0267 | 6-002801-0000 | Vymez. podložka, SECTRA, úkos 45°, AWB-I 138/40 | 91,83 Kč | ks |
|  | PR0268 | 6-002803-0000 | Vymez. podložka, SECTRA, úkos 45°, AWB-I 150/40 | 125,78 Kč | ks |
|  | PR0269 | 6-002805-0000 | Vymez. podložka, SECTRA, úkos 45°, AWB-I 165/40 | 123,68 Kč | ks |
|  | PR0270 | 6-002807-0000 | Vymez. podložka, SECTRA, úkos 45°, AWB-I 180/40 | 140,85 Kč | ks |
|  | PR0271/00-2 | 6-002811-00002 | Bočnice, proti hmyzu, zaoblená, BKR-I-N 138 PÁR | 296,88 Kč | ks |
|  | PR0271/01-2 | 6-002811-00012 | Bočnice, proti hmyzu, zaoblená, BKR-I-N 138 PÁR | 347,20 Kč | ks |
|  | PR0271/03-2 | 6-002811-00032 | Bočnice, proti hmyzu, zaoblená, BKR-I-N 138 PÁR | 347,20 Kč | ks |
|  | PR0272/00-2 | 6-002812-00002 | Bočnice, proti hmyzu, zaoblená, BKR-I-N 165 PÁR | 339,65 Kč | ks |
|  | PR0272/01-2 | 6-002812-00012 | Bočnice, proti hmyzu, zaoblená, BKR-I-N 165 PÁR | 403,80 Kč | ks |
|  | PR0272/03-2 | 6-002812-00032 | Bočnice, proti hmyzu, zaoblená, BKR-I-N 165 PÁR | 403,80 Kč | ks |





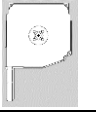
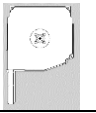
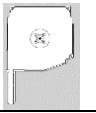
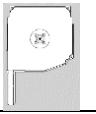





| | | | | | |
|---|-------------|----------------|---|-----------|----|
|  | PR0273/00-2 | 6-002814-00002 | Bočnice, proti hmyzu, zaoblená, BKR-I-N 180 - PÁR | 460,40 Kč | ks |
|  | PR0273/01-2 | 6-002814-00012 | Bočnice, proti hmyzu, zaoblená, BKR-I-N 180 - PÁR | 522,03 Kč | ks |
|  | PR0273/03-2 | 6-002814-00032 | Bočnice, proti hmyzu, zaoblená, BKR-I-N 180 - PÁR | 522,03 Kč | ks |
|  | PR0274 | 6-002816-0000 | Vymez. podložka, SECTRA, zaobl. AWBR-I 138/40 | 140,40 Kč | ks |
|  | PR0275 | 6-002819-0000 | Vymez. podložka, SECTRA, zaobl. AWBR-I 165/40 | 168,90 Kč | ks |
|  | PR0276 | 6-002821-0000 | Vymez. podložka, SECTRA, zaobl. AWBR-I 180/40 | 149,70 Kč | ks |
|  | PR0277/00-2 | 6-002826-00002 | Bočnice, proti hmyzu, čtvrtk., BKVR-I-N 150 - PÁR | 637,83 Kč | ks |
|  | PR0277/01-2 | 6-002826-00012 | Bočnice, proti hmyzu, čtvrtk., BKVR-I-N 150 - PÁR | 652,90 Kč | ks |
|  | PR0277/03-2 | 6-002826-00032 | Bočnice, proti hmyzu, čtvrtk., BKVR-I-N 150 - PÁR | 652,90 Kč | ks |
|  | PR0278/00-2 | 6-002828-00002 | Bočnice, proti hmyzu, čtvrtk., BKVR-I-N 165 - PÁR | 670,50 Kč | ks |
|  | PR0278/01-2 | 6-002828-00012 | Bočnice, proti hmyzu, čtvrtk., BKVR-I-N 165 - PÁR | 685,58 Kč | ks |
|  | PR0278/03-2 | 6-002828-00032 | Bočnice, proti hmyzu, čtvrtk., BKVR-I-N 165 - PÁR | 685,58 Kč | ks |
|  | PR0279/00-2 | 6-002829-00002 | Bočnice, proti hmyzu, čtvrtk., BKVR-I-N 180 - PÁR | 685,58 Kč | ks |
|  | PR0279/01-2 | 6-002829-00012 | Bočnice, proti hmyzu, čtvrtk., BKVR-I-N 180 - PÁR | 727,10 Kč | ks |
|  | PR0279/03-2 | 6-002829-00032 | Bočnice, proti hmyzu, čtvrtk., BKVR-I-N 180 - PÁR | 727,10 Kč | ks |
|  | PR0280 | 6-002842-0000 | Vymez. podložka, SECTRA, 1/4R, AWBVR-I 150/40 | 138,35 Kč | ks |

| | | | | | |
|---|-------------|---------------|--|-----------|----|
|  | PR0281 | 6-002845-0000 | Vymez. podložka, SECTRA, 1/4R, AWBVR-I 165/40 | 145,90 Kč | ks |
|  | PR0282 | 6-002847-0000 | Vymez. podložka, SECTRA, 1/4R, AWBVR-I 180/40 | 148,45 Kč | ks |
|  | PR0284/0200 | 6-003055-0000 | Úhelník k příšroub.klikového navijče-bílý | 283,05 Kč | ks |
|  | PR0284/0300 | 6-003055-0021 | Úhelník k příšroub.klikového navijče-hnědý | 278,00 Kč | ks |
| | PR0285 | 6-003139-0000 | Sponka TYP 71/03 | 0,05 Kč | ks |
|  | PR0286/0100 | 6-003640-0100 | Selve-páskový částečně zapuštěný navijč,bez pásku | 334,60 Kč | ks |
|  | PR0286/0200 | 6-003640-0200 | Selve-páskový částečně zapuštěný navijč,bez pásku | 341,40 Kč | ks |
| | PR0288 | 6-003664-0000 | Vložka těsnění kulatá do koncové lamely | 21,38 Kč | m |
|  | PR0290/00 | 6-003879-0000 | Vodící lišta A3-ES s drážkou pro kryt FAR-ES BEZB. | 393,48 Kč | m |
|  | PR0290/01 | 6-003879-0001 | Vodící lišta A3-ES s drážkou pro kryt FAR-ES B 01, bílá | 520,78 Kč | m |
|  | PR0290/03 | 6-003879-0003 | Vodící lišta A3-ES s drážkou pro kryt FAR-ES H 03, hnědá | 520,78 Kč | m |
|  | PR0292 | 6-006301-0000 | Trychtýř k odnímaní kliky | 379,93 Kč | ks |
|  | PR0293 | 6-006301-0001 | Kolík 4x24 k odnímaní kliky | 6,30 Kč | ks |
|  | PR0294 | 6-006562-0090 | Klapa revizní AL bez kartáčku, vnitřní, 55mm | 388,70 Kč | m |
|  | PR0297 | 6-006875-0000 | Kartáček šikmý - pro V.L. A20 | 36,48 Kč | m |
|  | PR0298/0200 | 6-006981-0200 | Náběh A3 -PÁR | 27,03 Kč | ks |

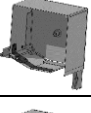
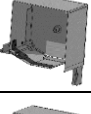
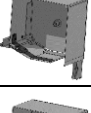
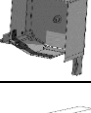
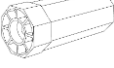
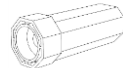
| | | | | | |
|---|-------------|---------------|--|-------------|----|
| | PR0300 | 6-009813-0004 | PVC zarážka pro koncovou lamelu 30mm - šedá | 14,50 Kč | ks |
|  | PR0302 | 6-010475-0000 | Pružinová mech. - od šíře 720 s brzdou | 1 412,70 Kč | ks |
|  | PR0303 | 6-010476-0000 | Pružinová mech. - do šíře 720 bez brzdy | 1 030,28 Kč | ks |
|  | PR0304/0200 | 6-010576-0200 | Náběh A15/A20 -PÁR | 42,78 Kč | ks |
|  | PR0327 | 6-011037-0090 | Klapa revizní AL bez kartáčku, vnitřní, 110 mm | 476,75 Kč | m |
| | PR0328 | 6-011038-0090 | Klapa revizní AL bez kartáčku, vnější | 415,13 Kč | m |
|  | PR0329/00 | 6-003880-0000 | Zaoblený kryt vodící lišty FAR-ES(pro V.L. A 3 ES), bezbarvá | 312,45 Kč | m |
|  | PR0329/01 | 6-003880-0001 | Zaoblený kryt vodící lišty FAR-ES(pro V.L. A 3 ES), bílá | 407,98 Kč | m |
|  | PR0329/03 | 6-003880-0003 | Zaoblený kryt vodící lišty FAR-ES(pro V.L. A 3 ES), hnědá | 407,98 Kč | m |
|  | PR0330/00 | 6-012000-0000 | Zaoblený kryt vodící lišty FAG-ES(pro V.L. A 3 ES), bezbarvá | 306,68 Kč | m |
|  | PR0330/01 | 6-012000-0001 | Zaoblený kryt vodící lišty FAG-ES(pro V.L. A 3 ES), bílá | 407,98 Kč | m |
|  | PR0330/03 | 6-012000-0003 | Zaoblený kryt vodící lišty FAG-ES(pro V.L. A 3 ES), hnědá | 407,98 Kč | m |
|  | PR0331/00 | 6-012001-0000 | Ukončovací lišta pro zabezpečovací rolety SL-ES, bezbarvá | 363,20 Kč | m |
|  | PR0331/01 | 6-012001-0001 | Ukončovací lišta pro zabezpečovací rolety SL-ES, bílá | 457,10 Kč | m |
|  | PR0331/03 | 6-012001-0003 | Ukončovací lišta pro zabezpečovací rolety SL-ES, hnědá | 457,10 Kč | m |
|  | PR0332/9004 | 6-012002-9004 | Zátka pro SL-ES, černá | 26,75 Kč | ks |

| | | | | | |
|---|-------------|----------------|--|-----------|----|
|  | PR0345/01 | 6-002073-0001 | Kryt šroubu dvojdišný PVC - BÍLÝ | 3,80 Kč | ks |
|  | PR0345/02 | 6-002073-0002 | Kryt šroubu dvojdišný PVC - HNĚDÝ 8014 | 3,80 Kč | ks |
|  | PR0345/04 | 6-002073-0004 | Kryt šroubu dvojdišný PVC - ŠEDÝ | 8,80 Kč | ks |
|  | PR0345/05 | 6-002073-0005 | Kryt šroubu dvojdišný PVC - BĚŽOVÝ | 10,08 Kč | ks |
|  | PR0345/38 | 6-002073-0038 | Kryt šroubu dvojdišný PVC - RAL 8003 | 3,80 Kč | ks |
|  | PR0345/7016 | 6-002073-7016 | Kryt šroubu dvojdišný PVC - ANTRACIT | 4,45 Kč | ks |
|  | PR0359/00 | 6-012011-0000 | Omitací lišta PS-V 90°, bezbarvá | 247,85 Kč | m |
|  | PR0359/01 | 6-012011-0001 | Omitací lišta PS-V 90°, bílá | 369,85 Kč | m |
|  | PR0359/03 | 6-012011-0003 | Omitací lišta PS-V 90°, hnĚdá | 369,85 Kč | m |
|  | PR0359/2178 | 6-012011-2178 | Omitací lišta PS-V 90°, zlatý dub | 591,25 Kč | m |
|  | PR0359/2179 | 6-012011-2179 | Omitací lišta PS-V 90°, ořech | 591,25 Kč | m |
|  | PR0360/00-2 | 6-001771-00002 | Bočnice, 45°, BKS-N 150 -PÁR | 242,38 Kč | ks |
|  | PR0360/01-2 | 6-001771-00012 | Bočnice, 45°, BKS-N 150 -PÁR | 268,45 Kč | ks |
|  | PR0360/03-2 | 6-001771-00032 | Bočnice, 45°, BKS-N 150 -PÁR | 268,45 Kč | ks |
|  | PR0361/00 | 6-001861-0000 | Válcovaná schránka, zaoblená ROS 150, bezbarvá | 693,00 Kč | m |
|  | PR0361/01 | 6-001861-0001 | Válcovaná schránka, zaoblená ROS 150 - bílá | 721,95 Kč | m |

| | | | | | |
|---|-------------|----------------|--|-----------|----|
|  | PR0361/03 | 6-001861-0003 | Válcovaná schránka, zaoblená ROS 150 - hnědá | 721,95 Kč | m |
|  | PR0362/00 | 6-001863-0000 | Válcovaná schránka, zaoblená RUS 150, bezbarvá | 558,45 Kč | m |
|  | PR0362/01 | 6-001863-0001 | Válcovaná schránka, zaoblená RUS 150 - bílá | 574,38 Kč | m |
|  | PR0362/03 | 6-001863-0003 | Válcovaná schránka, zaoblená RUS 150 - hnědá | 574,38 Kč | m |
|  | PR0363/00-2 | 6-001864-00002 | Bočnice, kulatá, BKR-N 150 -PÁR | 277,38 Kč | ks |
|  | PR0363/01-2 | 6-001864-00012 | Bočnice, kulatá, BKR-N 150 -PÁR | 313,25 Kč | ks |
|  | PR0363/03-2 | 6-001864-00032 | Bočnice, kulatá, BKR-N 150 -PÁR | 313,25 Kč | ks |
|  | PR0364-2 | 6-009922-01252 | Bočnice, 20°, BKS-N, 125, P, pro kombinaci. - KS | 374,88 Kč | ks |
|  | PR0365-2 | 6-009922-01382 | Bočnice, 20°, BKS-N, 138, P, pro kombinaci. - KS | 392,50 Kč | ks |
|  | PR0366-2 | 6-009922-01502 | Bočnice, 20°, BKS-N, 150, P, pro kombinaci. - KS | 418,90 Kč | ks |
|  | PR0367-2 | 6-009922-01652 | Bočnice, 20°, BKS-N, 165, P, pro kombinaci. - KS | 439,03 Kč | ks |
|  | PR0369-2 | 6-009922-02052 | Bočnice, 20°, BKS-N, 205, P, pro kombinaci. - KS | 590,00 Kč | ks |
|  | PR0370-2 | 6-009923-01252 | Bočnice, 20°, BKS-N, 125, L, pro kombinaci. - KS | 374,88 Kč | ks |
|  | PR0371-2 | 6-009923-01382 | Bočnice, 20°, BKS-N, 138, L, pro kombinaci. - KS | 393,75 Kč | ks |
|  | PR0372-2 | 6-009923-01502 | Bočnice, 20°, BKS-N, 150, L, pro kombinaci. - KS | 418,90 Kč | ks |
|  | PR0373-2 | 6-009923-01652 | Bočnice, 20°, BKS-N, 165, L, pro kombinaci. - KS | 439,03 Kč | ks |

| | | | | | |
|---|-------------|----------------|---|-----------|----|
|  | PR0374-2 | 6-009923-01802 | Bočnice, 20°, BKS-N, 180, L, pro kombinaci - KS | 476,75 Kč | ks |
|  | PR0375-2 | 6-009923-02052 | Bočnice, 20°, BKS-N, 205, L, pro kombinaci - KS | 590,00 Kč | ks |
|  | PR0376 | 6-011208-0125 | Vyztužovací úhelník PT 20 st., dvoudílný 125 mm | 387,45 Kč | ks |
|  | PR0377 | 6-011208-0138 | Vyztužovací úhelník PT 20 st., dvoudílný 138 mm | 387,45 Kč | ks |
|  | PR0378 | 6-011208-0150 | Vyztužovací úhelník PT 20 st., dvoudílný 150 mm | 387,45 Kč | ks |
|  | PR0379 | 6-011208-0165 | Vyztužovací úhelník PT 20 st., dvoudílný 165 mm | 387,45 Kč | ks |
|  | PR0380 | 6-011208-0180 | Vyztužovací úhelník PT 20 st., dvoudílný 180 mm | 387,45 Kč | ks |
|  | PR0381 | 6-011208-0205 | Vyztužovací úhelník PT 20 st., dvoudílný 205 mm | 387,45 Kč | ks |
|  | PR0425 | 6-012146-0000 | Válcovaná zátka 150 mm | 155,98 Kč | ks |
|  | PR0426 | 6-012147-0000 | Válcovaná zátka 104 mm | 62,90 Kč | ks |
|  | PR0430 | 6-001796-0000 | Těsnicí vložka z PVC - oboustranná | 25,15 Kč | m |
|  | PR0431/00 | 6-010977-0000 | Ukončovací lišta SL KU-N, bezbarvá | 149,70 Kč | m |
|  | PR0431/01 | 6-010977-0001 | Ukončovací lišta SL KU-N BÍLÁ 01 | 230,23 Kč | m |
|  | PR0431/03 | 6-010977-0003 | Ukončovací lišta SL KU-N HNĚDÁ 03 | 230,23 Kč | m |
|  | PR0431/08 | 6-010977-0008 | Ukončovací lišta SL KU-N STŘÍBRNÁ 08 | 230,23 Kč | m |
|  | PR0431/2178 | 6-010977-2178 | Ukončovací lišta SL-KU-N RENOLIT 2178 | 475,50 Kč | m |





| | | | | | |
|---|-------------|----------------|---|-----------|----|
|  | PR0431/2179 | 6-010977-2179 | Ukončovací lišta SL-KU-N RENOLIT 2179 | 475,50 Kč | m |
|  | PR0433 | 6-001943-0000 | Vymez. podložka, SECTRA, úkos 20°, AWB-I 138/40 | 91,83 Kč | ks |
|  | PR0434 | 6-002785-0000 | Vymez. podložka, SECTRA, úkos 20°, AWB-I 138/60 | 105,68 Kč | ks |
|  | PR0434-2 | 6-002785-00002 | Vymezovací podložka AWB-I 138/60,universal | 90,55 Kč | ks |
|  | PR0435/00-2 | 6-011330-00002 | Bočnice, proti hmyzu, 90°, BK-I-N 138 -PÁR | 426,45 Kč | ks |
|  | PR0435/01-2 | 6-011330-00012 | Bočnice, proti hmyzu, 90°, BK-I-N 138 -PÁR | 469,23 Kč | ks |
|  | PR0435/03-2 | 6-011330-00032 | Bočnice, proti hmyzu, 90°, BK-I-N 138 -PÁR | 469,23 Kč | ks |
|  | PR0436 | 6-011331-0000 | Vymez. podložka, SECTRA, úkos 90°, AWB-I 180/40 | 140,40 Kč | ks |
|  | PR0437 | 6-011332-0000 | Vymez. podložka, SECTRA, úkos 90°, AWB-I 165/40 | 125,90 Kč | ks |
|  | PR0438 | 6-011333-0000 | Vymez. podložka, SECTRA, úkos 90°, AWB-I 150/40 | 125,90 Kč | ks |
|  | PR0439 | 6-011334-0000 | Vymez. podložka, SECTRA, úkos 90°, AWB-I 138/40 | 105,68 Kč | ks |
|  | PR0440 | 6-001944-0000 | Vymez. podložka, SECTRA, úkos 20°, AWB-I 150/40 | 117,00 Kč | ks |
|  | PR0441-2 | 6-002788-00002 | Vymezovací podložka AWB-I 150/60,universal | 104,43 Kč | ks |
|  | PR0442/00-2 | 6-011329-00002 | Bočnice, proti hmyzu, 90°, BK-I-N 150 -PÁR | 442,83 Kč | ks |
|  | PR0442/01-2 | 6-011329-00012 | Bočnice, proti hmyzu, 90°, BK-I-N 150 -PÁR | 501,93 Kč | ks |
|  | PR0442/03-2 | 6-011329-00032 | Bočnice, proti hmyzu, 90°, BK-I-N 150 -PÁR | 501,93 Kč | ks |





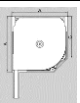
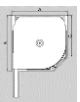
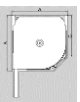
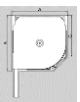











| | | | | | |
|---|-------------|----------------|---|-------------|----|
|  | PR0443/00-2 | 6-011325-00002 | Bočnice, proti hmyzu, zaoblená, BKR-I-N 150 PÁR | 314,50 Kč | ks |
|  | PR0443/01-2 | 6-011325-00012 | Bočnice, proti hmyzu, zaoblená, BKR-I-N 150 PÁR | 376,13 Kč | ks |
|  | PR0443/03-2 | 6-011325-00032 | Bočnice, proti hmyzu, zaoblená, BKR-I-N 150 PÁR | 376,13 Kč | ks |
|  | PR0444 | 6-011326-0000 | Vymez. podložka, SECTRA, zaobl. AWBR-I 150/40 | 156,25 Kč | ks |
|  | PR0445/00-2 | 6-011327-00002 | Bočnice, proti hmyzu, 90°, BK-I-N 180 -PÁR | 540,95 Kč | ks |
|  | PR0445/01-2 | 6-011327-00012 | Bočnice, proti hmyzu, 90°, BK-I-N 180 -PÁR | 625,23 Kč | ks |
|  | PR0445/03-2 | 6-011327-00032 | Bočnice, proti hmyzu, 90°, BK-I-N 180 -PÁR | 625,23 Kč | ks |
|  | PR0446/00-2 | 6-011328-00002 | Bočnice, proti hmyzu, 90°, BK-I-N 165 -PÁR | 471,73 Kč | ks |
|  | PR0446/01-2 | 6-011328-00012 | Bočnice, proti hmyzu, 90°, BK-I-N 165 -PÁR | 538,40 Kč | ks |
|  | PR0446/03-2 | 6-011328-00032 | Bočnice, proti hmyzu, 90°, BK-I-N 165 -PÁR | 538,40 Kč | ks |
|  | PR0447 | 6-001945-0000 | Vymez. podložka, SECTRA, úkos 20°, AWB-I 165/40 | 117,00 Kč | ks |
|  | PR0448 | 6-002790-0000 | Vymez. podložka, SECTRA, úkos 20°, AWB-I 165/60 | 117,00 Kč | ks |
|  | PR0448-2 | 6-002790-00002 | Vymezovací podložka AWB-I 165/60, universal | 104,43 Kč | ks |
|  | PR0449 | 6-002793-0000 | Vymez. podložka, SECTRA, úkos 20°, AWB-I 180/60 | 130,83 Kč | ks |
|  | PR0449-2 | 6-002793-00002 | Vymezovací podložka AWB-I 180/60, universal | 118,25 Kč | ks |
|  | PR0450-2 | 6-008083-00002 | Bočnice, 20°, BKSDf-N,125, L, pro kombinaci -KS | 1 147,28 Kč | ks |

| | | | | | |
|---|----------|----------------|--|-------------|----|
|  | PR0451-2 | 6-008084-00002 | Bočnice, 20°, BKSDf-N,125, P, pro kombinaci -KS | 1 147,28 Kč | ks |
|  | PR0452-2 | 6-002368-00002 | Bočnice, 20°, BKSDf-N,138, L, pro kombinaci -KS | 1 084,38 Kč | ks |
|  | PR0453-2 | 6-002364-00002 | Bočnice, 20°, BKSDf-N,138, P, pro kombinaci -KS | 1 084,38 Kč | ks |
|  | PR0454-2 | 6-002367-00002 | Bočnice, 20°, BKSDf-N,150, L, pro kombinaci -KS | 1 135,95 Kč | ks |
|  | PR0455-2 | 6-002366-00002 | Bočnice, 20°, BKSDf-N,150, P, pro kombinaci -KS | 1 135,95 Kč | ks |
|  | PR0456-2 | 6-004940-00002 | Bočnice, 20°, BKSDf-N,165, L, pro kombinaci -KS | 1 297,00 Kč | ks |
|  | PR0457-2 | 6-004942-00002 | Bočnice, 20°, BKSDf-N,165, P, pro kombinaci -KS | 1 297,00 Kč | ks |
|  | PR0458-2 | 6-006453-00002 | Bočnice, 20°, BKSDf-N,180, L, pro kombinaci -KS | 1 348,55 Kč | ks |
|  | PR0459-2 | 6-006452-00002 | Bočnice, 20°, BKSDf-N,180, P, pro kombinaci -KS | 1 348,55 Kč | ks |
|  | PR0464 | 6-001801-0000 | Kartáček těsnící pro zatemnění 9mm | 51,58 Kč | m |
|  | PR0465 | 6-011337-0000 | Kartáček pro SL-I vzadu 12,5 mm | 33,95 Kč | m |
|  | PR0471 | 6-011033-0000 | Šňůrka se střapcem - ČERNÁ | 90,55 Kč | ks |
|  | PR0472 | 6-012059-0090 | Vyztužovací úhelník PT 90 st.pro PB Uni,pro RR 090 | 391,20 Kč | ks |
|  | PR0473 | 6-012059-0100 | Vyztužovací úhelník PT 90 st.pro PB Uni,pro RR 100 | 407,58 Kč | ks |
|  | PR0474 | 6-012059-0125 | Vyztužovací úhelník PT 90 st.pro PB Uni,pro RR 125 | 428,95 Kč | ks |
|  | PR0475 | 6-012059-0138 | Vyztužovací úhelník PT 90 st.pro PB Uni,pro RR 138 | 436,53 Kč | ks |

| | | | | | |
|---|--------|---------------|--|-----------|----|
|  | PR0476 | 6-002820-0000 | Vymez. podložka, SECTRA, zaobl. AWBR-I 165/60 | 170,98 Kč | ks |
|  | PR0478 | 6-002808-0000 | Vymez. podložka, SECTRA, úkos 45°, AWB-I 180/60 | 122,00 Kč | ks |
|  | PR0479 | 6-012470-0000 | Vymez. podložka, SECTRA, úkos 20°, AWB-I 205/60 | 166,45 Kč | ks |
|  | PR0480 | 6-002844-0000 | Vymez. podložka, SECTRA, 1/4R, AWBVR-I 150/60 | 123,28 Kč | ks |
|  | PR0481 | 6-012472-0000 | Vymez. podložka, SECTRA, úkos 45°, AWB-I 205/60 | 166,45 Kč | ks |
|  | PR0482 | 6-002818-0000 | Vymez. podložka, SECTRA, zaobl. AWBR-I 138/60 | 122,00 Kč | ks |
|  | PR0483 | 6-002848-0000 | Vymez. podložka, SECTRA, 1/4R, AWBVR-I 180/60 | 148,45 Kč | ks |
|  | PR0484 | 6-002417-0000 | Vymez. podložka, SECTRA, úkos 90°, AWB-I 138/60 | 121,53 Kč | ks |
|  | PR0486 | 6-002802-0000 | Vymez. podložka, SECTRA, úkos 45°, AWB-I 138/60 | 91,83 Kč | ks |
|  | PR0487 | 6-002804-0000 | Vymez. podložka, SECTRA, úkos 45°, AWB-I 150/60 | 127,03 Kč | ks |
|  | PR0492 | 6-002786-0000 | Vymez. podložka, SECTRA, zaobl. AWBR-I 150/60 | 156,25 Kč | ks |
|  | PR0496 | 6-012471-0000 | Vymez. podložka, SECTRA, úkos 45°, AWB-I 205/40 | 166,45 Kč | ks |
|  | PR0497 | 6-002846-0000 | Vymez. podložka, SECTRA, 1/4R, AWBVR-I 165/60 | 145,90 Kč | ks |
|  | PR0498 | 6-002822-0000 | Vymez. podložka, SECTRA, zaobl. AWBR-I 180/60 | 172,58 Kč | ks |
|  | PR0499 | 6-002789-0000 | Vymez. podložka, SECTRA, úkos 20°, AWB-I 205/40 | 166,45 Kč | ks |
|  | PR0500 | 6-002806-0000 | Vymez. podložka, SECTRA, úkos 45°, AWB-I 165/60 | 109,43 Kč | ks |













| | | | | | |
|---|----------|----------------|---|-----------|----|
|  | PR0501 | 6-002438-0000 | Vymez. podložka, SECTRA, úkos 90°, AWB-I 150/60 | 125,90 Kč | ks |
|  | PR0502 | 6-010976-0000 | Těsnící vložka z PVC - pro SL-KU-N | 31,45 Kč | m |
|  | PR0503-2 | 6-012476-00002 | Bočnice, 20°, L, BKS-I-N, 138, pro kombinaci, KS | 398,80 Kč | ks |
|  | PR0504-2 | 6-012475-00002 | Bočnice, 20°, L, BKS-I-N, 150, pro kombinaci, KS | 437,78 Kč | ks |
|  | PR0505-2 | 6-012474-00002 | Bočnice, 20°, L, BKS-I-N, 165, pro kombinaci, KS | 450,35 Kč | ks |
|  | PR0507-2 | 6-012479-00002 | Bočnice, 20°, P, BKS-I-N, 150, pro kombinaci, -KS | 437,78 Kč | ks |
|  | PR0508-2 | 6-012478-00002 | Bočnice, 20°, P, BKS-I-N, 165, pro kombinaci, -KS | 450,35 Kč | ks |
|  | PR0600-2 | 6-012480-00002 | Bočnice, 20°, P, BKS-I-N, 138, pro kombinaci, -KS | 398,80 Kč | ks |
|  | PR0606-2 | 6-002411-00002 | Vymezovací podložka AWB 125/60,universal | 85,55 Kč | ks |
|  | PR0607-2 | 6-002413-00002 | Vymezovací podložka AWB 138/60,universal | 90,55 Kč | ks |
|  | PR0608-2 | 6-002415-00002 | Vymezovací podložka AWB 150/60,universal | 104,43 Kč | ks |
|  | PR0609-2 | 6-002416-00002 | Vymezovací podložka AWB 165/60,universal | 104,43 Kč | ks |
|  | PR0610-2 | 6-002419-00002 | Vymezovací podložka AWB 180/60,universal | 118,25 Kč | ks |
|  | PR0611-2 | 6-002421-00002 | Vymezovací podložka AWB 205/60,universal | 143,40 Kč | ks |
| | PR0648/1 | 6-013917-0000 | Závěs Octoeasy - jednočlánekový,hř.40mm,box 125-165 | 230,23 Kč | ks |
| | PR0648/2 | 6-013918-0000 | Závěs Octoeasy - jednočlánekový,hř.60mm,box 125-165 | 217,65 Kč | ks |

| | | | | | |
|---|----------|----------------|---|-------------|----|
| | PR0648/3 | 6-013919-0000 | Závěs Octoeasy - dvoučlánekový, hř. 40mm, box 180-205 | 362,30 Kč | ks |
| | PR0648/4 | 6-013920-0000 | Závěs Octoeasy - dvoučlánekový, hř. 60mm, box 180-205 | 284,30 Kč | ks |
| | PR0653 | 6-015016-0000 | Úchyt pro Insecta, 138 | 71,68 Kč | ks |
| | PR0653/1 | 6-015017-0000 | Úchyt pro Insecta, 150-205 | 71,68 Kč | ks |
| | PR0655 | 6-015020-0000 | Vrut plastový pro bočnice rolet, Pine Tree Clip | 19,25 Kč | ks |
|  | PR0657 | 6-015238-01252 | Bočnice, 45°, BKS-N, 125, L, pro kombinaci, - KS | 1 147,28 Kč | ks |
|  | PR0658 | 6-015238-01382 | Bočnice, 45°, BKS-N, 138, L, pro kombinaci, - KS | 1 247,90 Kč | ks |
|  | PR0659 | 6-015238-01502 | Bočnice, 45°, BKS-N, 150, L, pro kombinaci, - KS | 1 307,03 Kč | ks |
|  | PR0660 | 6-015238-01652 | Bočnice, 45°, BKS-N, 165, L, pro kombinaci, - KS | 1 297,00 Kč | ks |
|  | PR0661 | 6-015238-01802 | Bočnice, 45°, BKS-N, 180, L, pro kombinaci, - KS | 1 348,55 Kč | ks |
|  | PR0662 | 6-015238-02052 | Bočnice, 45°, BKS-N, 205, L, pro kombinaci, - KS | 1 435,35 Kč | ks |
|  | PR0663 | 6-015239-01252 | Bočnice, 45°, BKS-N, 125, P, pro kombinaci, - KS | 1 147,28 Kč | ks |
|  | PR0664 | 6-015239-01382 | Bočnice, 45°, BKS-N, 138, P, pro kombinaci, - KS | 1 247,90 Kč | ks |
|  | PR0665 | 6-015239-01502 | Bočnice, 45°, BKS-N, 150, P, pro kombinaci, - KS | 1 307,03 Kč | ks |
|  | PR0666 | 6-015239-01652 | Bočnice, 45°, BKS-N, 165, P, pro kombinaci, - KS | 1 297,00 Kč | ks |
|  | PR0667 | 6-015239-01802 | Bočnice, 45°, BKS-N, 180, P, pro kombinaci, - KS | 1 348,55 Kč | ks |

| | | | | | |
|---|--------|----------------|--|-------------|----|
|  | PR0668 | 6-015239-02052 | Bočnice, 45°, BKS-N, 205, P, pro kombinaci, -KS | 1 435,35 Kč | ks |
|  | PR0669 | 6-015240-01252 | Bočnice, 90°, BK-N, 125, L, pro kombinaci, -KS | 437,78 Kč | ks |
|  | PR0670 | 6-015240-01382 | Bočnice, 90°, BK-N, 138, L, pro kombinaci, -KS | 496,88 Kč | ks |
|  | PR0671 | 6-015240-01502 | Bočnice, 90°, BK-N, 150, L, pro kombinaci, -KS | 514,50 Kč | ks |
|  | PR0672 | 6-015240-01652 | Bočnice, 90°, BK-N, 165, L, pro kombinaci, -KS | 543,48 Kč | ks |
|  | PR0673 | 6-015240-01802 | Bočnice, 90°, BK-N, 180, L, pro kombinaci, -KS | 588,75 Kč | ks |
|  | PR0674 | 6-015240-02052 | Bočnice, 90°, BK-N, 205, L, pro kombinaci -KS | 655,43 Kč | ks |
|  | PR0675 | 6-015241-01252 | Bočnice, 90°, BK-N, 125, P, pro kombinaci, -KS | 437,78 Kč | ks |
|  | PR0676 | 6-015241-01382 | Bočnice, 90°, BK-N, 138, P, pro kombinaci, -KS | 496,88 Kč | ks |
|  | PR0677 | 6-015241-01502 | Bočnice, 90°, BK-N, 150, P, pro kombinaci, -KS | 514,50 Kč | ks |
|  | PR0678 | 6-015241-01652 | Bočnice, 90°, BK-N, 165, P, pro kombinaci, -KS | 543,48 Kč | ks |
|  | PR0679 | 6-015241-01802 | Bočnice, 90°, BK-N, 180, P, pro kombinaci, -KS | 588,75 Kč | ks |
|  | PR0680 | 6-015241-02052 | Bočnice, 90°, BK-N, 205, P, pro kombinaci -KS | 655,43 Kč | ks |
|  | PR0681 | 6-015242-01382 | Bočnice, kulatá, BKR-N, 138, L, pro kombinaci, -KS | 398,80 Kč | ks |
|  | PR0682 | 6-015242-01502 | Bočnice, kulatá, BKR-N, 150, L, pro kombinaci, -KS | 432,73 Kč | ks |
|  | PR0683 | 6-015242-01652 | Bočnice, kulatá, BKR-N, 165, L, pro kombinaci, -KS | 464,18 Kč | ks |

| | | | | | |
|---|--------|----------------|--|-----------|----|
|  | PR0684 | 6-015242-01802 | Bočnice, kulatá, BKR-N, 180, L, pro kombinaci, -KS | 501,93 Kč | ks |
|  | PR0685 | 6-015242-02052 | Bočnice, kulatá, BKR-N, 205, L, pro kombinaci, -KS | 592,55 Kč | ks |
|  | PR0686 | 6-015243-01382 | Bočnice, kulatá, BKR-N, 138, P, pro kombinaci, -KS | 398,80 Kč | ks |
|  | PR0687 | 6-015243-01502 | Bočnice, kulatá, BKR-N, 150, P, pro kombinaci, -KS | 432,73 Kč | ks |
|  | PR0688 | 6-015243-01652 | Bočnice, kulatá, BKR-N, 165, P, pro kombinaci, -KS | 464,18 Kč | ks |
|  | PR0689 | 6-015243-01802 | Bočnice, kulatá, BKR-N, 180, P, pro kombinaci, -KS | 501,93 Kč | ks |
|  | PR0690 | 6-015243-02052 | Bočnice, kulatá, BKR-N, 205, P, pro kombinaci, -KS | 592,55 Kč | ks |
|  | PR0691 | 6-015244-01382 | Bočnice, čtvrtkulatá, BKVR-N, 138, L, pro komb., -KS | 655,43 Kč | ks |
|  | PR0692 | 6-015244-01502 | Bočnice, čtvrtkulatá, BKVR-N, 150, L, pro komb., -KS | 680,58 Kč | ks |
|  | PR0693 | 6-015244-01652 | Bočnice, čtvrtkulatá, BKVR-N, 165, L, pro komb., -KS | 707,00 Kč | ks |
|  | PR0694 | 6-015244-01802 | Bočnice, čtvrtkulatá, BKVR-N, 180, L, pro komb., -KS | 745,98 Kč | ks |
|  | PR0695 | 6-015244-02052 | Bočnice, čtvrtkulatá, BKVR-N, 205, L, pro komb., -KS | 888,13 Kč | ks |
|  | PR0696 | 6-015245-01382 | Bočnice, čtvrtkulatá, BKVR-N, 138, P, pro komb., -KS | 655,43 Kč | ks |
|  | PR0697 | 6-015245-01502 | Bočnice, čtvrtkulatá, BKVR-N, 150, P, pro komb., -KS | 680,58 Kč | ks |
|  | PR0698 | 6-015245-01652 | Bočnice, čtvrtkulatá, BKVR-N, 165, P, pro komb., -KS | 707,00 Kč | ks |
|  | PR0699 | 6-015245-01802 | Bočnice, čtvrtkulatá, BKVR-N, 180, P, pro komb., -KS | 745,98 Kč | ks |

| | | | | | |
|---|--------|----------------|--|-------------|----|
|  | PR0700 | 6-015245-02052 | Bočnice, čtvrtkulatá, BKVR-N, 205, P, pro komb., -KS | 888,13 Kč | ks |
|  | PR0701 | 6-015246-01252 | Bočnice, 45°, BKSDf-N, 125, L, pro kombinaci -KS | 997,58 Kč | ks |
|  | PR0702 | 6-015246-01382 | Bočnice, 45°, BKSDf-N, 138, L, pro kombinaci -KS | 1 084,38 Kč | ks |
|  | PR0703 | 6-015246-01502 | Bočnice, 45°, BKSDf-N, 150, L, pro kombinaci -KS | 1 135,95 Kč | ks |
|  | PR0704 | 6-015246-01652 | Bočnice, 45°, BKSDf-N, 165, L, pro kombinaci -KS | 1 127,15 Kč | ks |
|  | PR0705 | 6-015246-01802 | Bočnice, 45°, BKSDf-N, 180, L, pro kombinaci -KS | 1 172,43 Kč | ks |
|  | PR0706 | 6-015246-02052 | Bočnice, 45°, BKSDf-N, 205, L, pro kombinaci -KS | 1 247,90 Kč | ks |
|  | PR0707 | 6-015247-01252 | Bočnice, 45°, BKSDf-N, 125, P, pro kombinaci -KS | 997,58 Kč | ks |
|  | PR0708 | 6-015247-01382 | Bočnice, 45°, BKSDf-N, 138, P, pro kombinaci -KS | 1 084,38 Kč | ks |
|  | PR0709 | 6-015247-01502 | Bočnice, 45°, BKSDf-N, 150, P, pro kombinaci -KS | 1 135,95 Kč | ks |
|  | PR0710 | 6-015247-01652 | Bočnice, 45°, BKSDf-N, 165, P, pro kombinaci -KS | 1 127,15 Kč | ks |
|  | PR0711 | 6-015247-01802 | Bočnice, 45°, BKSDf-N, 180, P, pro kombinaci -KS | 1 172,43 Kč | ks |
|  | PR0712 | 6-015247-02052 | Bočnice, 45°, BKSDf-N, 205, P, pro kombinaci -KS | 1 247,90 Kč | ks |
|  | PR0713 | 6-015248-02052 | Bočnice, 20°, BKSDf-N, 205, P, pro kombinaci -KS | 1 435,35 Kč | ks |
|  | PR0714 | 6-015249-02052 | Bočnice, 20°, BKSDf-N, 205, L, pro kombinaci -KS | 1 435,35 Kč | ks |
|  | PR0715 | 6-015250-01252 | Bočnice, 90°, BKDF-N, 125, L, pro kombinaci, -KS | 1 147,28 Kč | ks |

| | | | | | |
|---|--------|----------------|--|-------------|----|
|  | PR0716 | 6-015250-01382 | Bočnice, 90°, BKDF-N, 138, L, pro kombinaci, -KS | 1 247,90 Kč | ks |
|  | PR0717 | 6-015250-01502 | Bočnice, 90°, BKDF-N, 150, L, pro kombinaci, -KS | 1 307,03 Kč | ks |
|  | PR0718 | 6-015250-01652 | Bočnice, 90°, BKDF-N, 165, L, pro kombinaci, -KS | 1 297,00 Kč | ks |
|  | PR0719 | 6-015250-01802 | Bočnice, 90°, BKDF-N, 180, L, pro kombinaci, -KS | 1 348,55 Kč | ks |
|  | PR0720 | 6-015250-02052 | Bočnice, 90°, BKDF-N, 205, L, pro kombinaci, -KS | 1 435,35 Kč | ks |
|  | PR0721 | 6-015251-01252 | Bočnice, 90°, BKDF-N, 125, P, pro kombinaci, -KS | 1 147,28 Kč | ks |
|  | PR0722 | 6-015251-01382 | Bočnice, 90°, BKDF-N, 138, P, pro kombinaci, -KS | 1 247,90 Kč | ks |
|  | PR0723 | 6-015251-01502 | Bočnice, 90°, BKDF-N, 150, P, pro kombinaci, -KS | 1 307,03 Kč | ks |
|  | PR0724 | 6-015251-01652 | Bočnice, 90°, BKDF-N, 165, P, pro kombinaci, -KS | 1 297,00 Kč | ks |
|  | PR0725 | 6-015251-01802 | Bočnice, 90°, BKDF-N, 180, P, pro kombinaci, -KS | 1 348,55 Kč | ks |
|  | PR0726 | 6-015251-02052 | Bočnice, 90°, BKDF-N, 205, P, pro kombinaci, -KS | 1 435,35 Kč | ks |
|  | PR0727 | 6-015252-01382 | Bočnice, kulatá, BKRDF-N, 138, L, pro komb., -KS | 1 247,90 Kč | ks |
|  | PR0728 | 6-015252-01502 | Bočnice, kulatá, BKRDF-N, 150, L, pro komb., -KS | 1 307,03 Kč | ks |
|  | PR0729 | 6-015252-01652 | Bočnice, kulatá, BKRDF-N, 165, L, pro komb., -KS | 1 297,00 Kč | ks |
|  | PR0730 | 6-015252-01802 | Bočnice, kulatá, BKRDF-N, 180, L, pro komb., -KS | 1 348,55 Kč | ks |
|  | PR0731 | 6-015252-02052 | Bočnice, kulatá, BKRDF-N, 205, L, pro komb., -KS | 1 435,35 Kč | ks |

















| | | | | | |
|---|--------|----------------|---|-------------|----|
|  | PR0732 | 6-015253-01382 | Bočnice, kulatá, BKRDF-N, 138, P, pro komb., -KS | 1 247,90 Kč | ks |
|  | PR0733 | 6-015253-01502 | Bočnice, kulatá, BKRDF-N, 150, P, pro komb., -KS | 1 307,03 Kč | ks |
|  | PR0734 | 6-015253-01652 | Bočnice, kulatá, BKRDF-N, 165, P, pro komb., -KS | 1 297,00 Kč | ks |
|  | PR0735 | 6-015253-01802 | Bočnice, kulatá, BKRDF-N, 180, P, pro komb., -KS | 1 348,55 Kč | ks |
|  | PR0736 | 6-015253-02052 | Bočnice, kulatá, BKRDF-N, 205, P, pro komb., -KS | 1 435,35 Kč | ks |
|  | PR0737 | 6-015254-01382 | Bočnice, čtvrtk, BKVRDF-N, 138, L, pro komb., KS | 1 247,90 Kč | ks |
|  | PR0738 | 6-015254-01502 | Bočnice, čtvrtk, BKVRDF-N, 150, L, pro komb., KS | 1 307,03 Kč | ks |
|  | PR0739 | 6-015254-01652 | Bočnice, čtvrtk, BKVRDF-N, 165, L, pro komb., KS | 1 297,00 Kč | ks |
|  | PR0740 | 6-015254-01802 | Bočnice, čtvrtk, BKVRDF-N, 180, L, pro komb., KS | 1 348,55 Kč | ks |
|  | PR0741 | 6-015254-02052 | Bočnice, čtvrtk, BKVRDF-N, 205, L, pro komb., KS | 1 435,35 Kč | ks |
|  | PR0742 | 6-015255-01382 | Bočnice, čtvrtk, BKVRDF-N, 138, P, pro komb., -KS | 1 247,90 Kč | ks |
|  | PR0743 | 6-015255-01502 | Bočnice, čtvrtk, BKVRDF-N, 150, P, pro komb., -KS | 1 307,03 Kč | ks |
|  | PR0744 | 6-015255-01652 | Bočnice, čtvrtk, BKVRDF-N, 165, P, pro komb., -KS | 1 297,00 Kč | ks |
|  | PR0745 | 6-015255-01802 | Bočnice, čtvrtk, BKVRDF-N, 180, P, pro komb., -KS | 1 348,55 Kč | ks |
|  | PR0746 | 6-015255-02052 | Bočnice, čtvrtk, BKVRDF-N, 205, P, pro komb., -KS | 1 435,35 Kč | ks |
|  | PR0749 | 6-009922-01802 | Bočnice, 20°, BKS-N, 180, P, pro kombinaci, -KS | 476,75 Kč | ks |

















| | | | | | |
|---|--------|----------------|---|-----------|----|
|  | PR0750 | 6-015273-00002 | Bočnice, 20°, L, BKS-I-N, 180, pro kombinaci, KS | 563,60 Kč | ks |
|  | PR0751 | 6-015274-00002 | Bočnice, 20°, P, BKS-I-N, 180, pro kombinaci, -KS | 563,60 Kč | ks |
|  | PR0752 | 6-015275-00002 | Bočnice, 45°, L, BKS-I-N, 138, pro kombinaci, KS | 459,15 Kč | ks |
|  | PR0753 | 6-015276-00002 | Bočnice, 45°, P, BKS-I-N, 138, pro kombinaci, -KS | 459,15 Kč | ks |
|  | PR0754 | 6-015277-00002 | Bočnice, 45°, L, BKS-I-N, 150, pro kombinaci, KS | 503,18 Kč | ks |
|  | PR0755 | 6-015278-00002 | Bočnice, 45°, P, BKS-I-N, 150, pro kombinaci, -KS | 503,18 Kč | ks |
|  | PR0756 | 6-015279-00002 | Bočnice, 45°, L, BKS-I-N, 165, pro kombinaci, KS | 518,28 Kč | ks |
|  | PR0757 | 6-015280-00002 | Bočnice, 45°, P, BKS-I-N, 165, pro kombinaci, -KS | 518,28 Kč | ks |
|  | PR0758 | 6-015281-00002 | Bočnice, 45°, L, BKS-I-N, 180, pro kombinaci, KS | 563,60 Kč | ks |
|  | PR0759 | 6-015282-00002 | Bočnice, 45°, P, BKS-I-N, 180, pro kombinaci, -KS | 563,60 Kč | ks |
|  | PR0760 | 6-015283-00002 | Bočnice, 90°, L, BK-I-N, 138, pro kombinaci, -KS | 910,78 Kč | ks |
|  | PR0761 | 6-015284-00002 | Bočnice, 90°, P, BK-I-N, 138, pro kombinaci, -KS | 910,78 Kč | ks |
|  | PR0762 | 6-015285-00002 | Bočnice, 90°, L, BK-I-N, 150, pro kombinaci, -KS | 928,40 Kč | ks |
|  | PR0763 | 6-015286-00002 | Bočnice, 90°, P, BK-I-N, 150, pro kombinaci, -KS | 928,40 Kč | ks |
|  | PR0764 | 6-015287-00002 | Bočnice, 90°, L, BK-I-N, 165, pro kombinaci, -KS | 961,10 Kč | ks |
|  | PR0765 | 6-015288-00002 | Bočnice, 90°, P, BK-I-N, 165, pro kombinaci, -KS | 961,10 Kč | ks |















| | | | | | |
|---|--------|----------------|--|-------------|----|
|  | PR0766 | 6-015289-00002 | Bočnice, 90°, L, BK-I-N, 180, pro kombinaci, -KS | 1 015,20 Kč | ks |
|  | PR0767 | 6-015290-00002 | Bočnice, 90°, P, BK-I-N, 180, pro kombinaci, -KS | 1 015,20 Kč | ks |
|  | PR0768 | 6-015291-00002 | Bočnice, kulatá, L, BKR-I-N,138, pro kombinaci,-KS | 476,75 Kč | ks |
|  | PR0769 | 6-015292-00002 | Bočnice, kulatá, P, BKR-I-N,138, pro kombinaci,-KS | 476,75 Kč | ks |
|  | PR0770 | 6-015293-00002 | Bočnice, kulatá, L, BKR-I-N,150, pro kombinaci,-KS | 501,93 Kč | ks |
|  | PR0771 | 6-015294-00002 | Bočnice, kulatá, P, BKR-I-N,150, pro kombinaci,-KS | 501,93 Kč | ks |
|  | PR0772 | 6-015295-00002 | Bočnice, kulatá, L, BKR-I-N,165, pro kombinaci,-KS | 524,58 Kč | ks |
|  | PR0773 | 6-015296-00002 | Bočnice, kulatá, P, BKR-I-N,165, pro kombinaci,-KS | 524,58 Kč | ks |
|  | PR0774 | 6-015297-00002 | Bočnice, kulatá, L, BKR-I-N,180, pro kombinaci,-KS | 647,85 Kč | ks |
|  | PR0775 | 6-015298-00002 | Bočnice, kulatá, P, BKR-I-N,180, pro kombinaci,-KS | 647,85 Kč | ks |
|  | PR0776 | 6-015299-00002 | Bočnice,čtvrtk., L,BKVR-I-N,150, pro kombinaci,-KS | 714,53 Kč | ks |
|  | PR0777 | 6-015300-00002 | Bočnice,čtvrtk., P,BKVR-I-N,150, pro kombinaci,-KS | 714,53 Kč | ks |
|  | PR0778 | 6-015301-00002 | Bočnice,čtvrtk., L,BKVR-I-N,165, pro kombinaci,-KS | 742,20 Kč | ks |
|  | PR0779 | 6-015302-00002 | Bočnice,čtvrtk., P,BKVR-I-N,165, pro kombinaci,-KS | 742,20 Kč | ks |
|  | PR0780 | 6-015303-00002 | Bočnice,čtvrtk., L,BKVR-I-N,180, pro kombinaci,-KS | 779,93 Kč | ks |
|  | PR0781 | 6-015304-00002 | Bočnice,čtvrtk., P,BKVR-I-N,180, pro kombinaci,-KS | 779,93 Kč | ks |

| | | | | | |
|---|------------|---------------|---|-----------|----|
|  | PR0788 | 3-03179-0000 | Doraz rolety | 169,25 Kč | ks |
| | PR0789 | 6-001799-0000 | Vložka těsnící úzká | 30,50 Kč | m |
|  | RHE001 | 6-006543-0000 | Držáky do překladu s nýtovanými maticemi (SADA) | 912,03 Kč | ks |
|  | RHE003/25 | 6-006547-0025 | Držák ložiska vyhnutý L=25mm | 51,58 Kč | ks |
|  | RHE004 | 6-006551-0000 | Ložisko kuličkové 42-12 - nylonové | 42,78 Kč | ks |
| | RHE005 | 6-006552-0000 | PVC průchodka pro pásek 22mm - 100mm | 100,63 Kč | ks |
|  | RHE006 | 6-006553-0000 | Hřidelová zátka 72mm | 42,78 Kč | ks |
|  | RHE006/150 | 6-006553-0150 | Hřidelová zátka 150mm | 83,00 Kč | ks |
|  | RHE007/170 | 6-006554-0170 | Řemenice pro pásek 22mm - pr. 170mm | 101,88 Kč | ks |
| | RHE008 | 6-006555-0000 | Navijec pásku 22mm - bez pásku | 206,33 Kč | ks |
| | RHE009/B | 6-006556-0001 | Přední kryt pro navijec pásku 22mm - bílý | 25,15 Kč | ks |
| | RHE009/H | 6-006556-0002 | Přední kryt pro navijec pásku 22mm - hnědý | 36,48 Kč | ks |
| | RHE010 | 6-006559-0000 | Zadní kryt pro navijec pásku 22mm | 72,98 Kč | ks |
|  | RHE011/B | 6-006560-0000 | Pásková průchodka s kartáčkem - bílá | 55,35 Kč | ks |
|  | RHE011/H | 6-006560-0001 | Pásková průchodka s kartáčkem - hnědá | 59,10 Kč | ks |
|  | RHE012/H | 6-006561-0002 | Pásek 22mm - hnědý | 18,88 Kč | m |





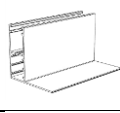
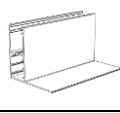

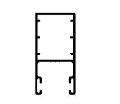



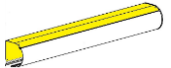

| | | | | | |
|---|-------------|---------------|---|-----------|----|
|  | RHE012/S | 6-006561-0004 | Pásek 22mm - šedý | 17,63 Kč | m |
| | RHE014 | 6-006563-0000 | Kartáček revizní klapky 6,7x18mm šedý | 30,20 Kč | m |
|  | RHE016 | 6-006565-0000 | Al. pouzdro vodící lišty | 334,03 Kč | m |
|  | RHE017/90 | 6-006566-0090 | Al. vodící lišta bez kartáčku - bezbarvá | 256,65 Kč | m |
|  | RP0291/200 | 6-006288-0001 | Otočná zarážka ABS - ČERNÁ - PÁR | 28,95 Kč | ks |
|  | SC 209 8014 | 6-001387-8014 | Držadlo Al venkovní HNĚDÉ | 210,13 Kč | ks |
|  | SC 209 9010 | 6-001387-9010 | Držadlo Al venkovní BÍLÉ | 210,13 Kč | ks |
|  | ZP0008 | 6-009196-0000 | Průchodka kabelu GUMOVÁ pr. 11/7 | 8,40 Kč | ks |
|  | ZP0013/0100 | 6-002066-0100 | Víčka krycí 10mm bílá | 3,88 Kč | ks |
|  | ZP0013/0300 | 6-002066-0300 | Víčka krycí 10mm šedá | 3,88 Kč | ks |
|  | ZP0013/0500 | 6-002066-0500 | Víčka krycí 10mm hnědá 8014 | 3,88 Kč | ks |
|  | ZP0013/0600 | 6-002066-0600 | Víčka krycí 10mm béžová | 3,88 Kč | ks |
|  | ZP0013/1300 | 6-002066-1300 | Víčka krycí 10mm antracit | 5,68 Kč | ks |
|  | ZP0013/8003 | 6-002066-8003 | Víčka krycí 10mm sv.hnědá RAL 8003 | 3,18 Kč | ks |
|  | PR0049/08 | 6-001684-0008 | Protlačovaná schránka, úkos 20°, RK 125, spodní | 345,95 Kč | m |
|  | PR0049/82 | 6-001684-0082 | Protlačovaná schránka, úkos 20°, RK 125, spodní | 345,95 Kč | m |

















| | | | | | |
|---|-----------|---------------|---|-----------|---|
|  | PR0050/08 | 6-001687-0008 | Protlačovaná schránka, úkos 20°, RK 138, spodní | 400,05 Kč | m |
|  | PR0050/82 | 6-001687-0082 | Protlačovaná schránka, úkos 20°, RK 138, spodní | 400,05 Kč | m |
|  | PR0051/08 | 6-001690-0008 | Protlačovaná schránka, úkos 20°, RK 150, spodní | 467,98 Kč | m |
|  | PR0051/82 | 6-001690-0082 | Protlačovaná schránka, úkos 20°, RK 150, spodní | 467,98 Kč | m |
|  | PR0052/08 | 6-001693-0008 | Protlačovaná schránka, úkos 20°, RK 165, spodní | 498,13 Kč | m |
|  | PR0052/82 | 6-001693-0082 | Protlačovaná schránka, úkos 20°, RK 165, spodní | 498,13 Kč | m |
|  | PR0053/08 | 6-001695-0008 | Protlačovaná schránka, úkos 20°, RK 180, spodní | 567,38 Kč | m |
|  | PR0053/82 | 6-001695-0082 | Protlačovaná schránka, úkos 20°, RK 180, spodní | 567,38 Kč | m |
|  | PR0025/08 | 6-001699-0008 | Válcovaná schránka, GOT 125 | 475,50 Kč | m |
|  | PR0025/82 | 6-001699-0082 | Válcovaná schránka, GOT 125 | 744,73 Kč | m |
|  | PR0001/08 | 6-001701-0008 | Válcovaná schránka, úkos 20°, GUTS 125 | 353,48 Kč | m |
|  | PR0001/82 | 6-001701-0082 | Válcovaná schránka, úkos 20°, GUTS 125 | 632,78 Kč | m |
|  | PR0026/08 | 6-001704-0008 | Válcovaná schránka, GOT 138 -stříbrná | 498,13 Kč | m |
|  | PR0026/82 | 6-001704-0082 | Válcovaná schránka, GOT 138 - antracit | 590,00 Kč | m |
|  | PR0002/08 | 6-001706-0008 | Válcovaná schránka, úkos 20°, GUTS 138 - stříbrná | 366,05 Kč | m |
|  | PR0002/82 | 6-001706-0082 | Válcovaná schránka, úkos 20°, GUTS 138 - antracit | 494,38 Kč | m |

















| | | | | | |
|---|-------------|----------------|---|-------------|----|
|  | PR0027/08 | 6-001708-0008 | Válcovaná schránka, GOT 150 - stříbrná | 543,48 Kč | m |
|  | PR0027/82 | 6-001708-0082 | Válcovaná schránka, GOT 150 - antracit | 630,28 Kč | m |
|  | PR0003/08 | 6-001712-0008 | Válcovaná schránka, úkos 20°, GUTS 150 - stříbrná | 430,23 Kč | m |
|  | PR0003/82 | 6-001712-0082 | Válcovaná schránka, úkos 20°, GUTS 150 - antracit | 514,50 Kč | m |
|  | PR0028/08 | 6-001716-0008 | Válcovaná schránka, GOT 165 - stříbrná | 630,28 Kč | m |
|  | PR0028/82 | 6-001716-0082 | Válcovaná schránka, GOT 165 - antracit | 675,55 Kč | m |
|  | PR0004/08 | 6-001718-0008 | Válcovaná schránka, úkos 20°, GUTS 165 - stříbrná | 475,50 Kč | m |
|  | PR0004/82 | 6-001718-0082 | Válcovaná schránka, úkos 20°, GUTS 165 - antracit | 567,38 Kč | m |
|  | PR0029/08 | 6-001721-0008 | Válcovaná schránka, GOT 180 - stříbrná | 690,63 Kč | m |
|  | PR0029/82 | 6-001721-0082 | Válcovaná schránka, GOT 180 - antracit | 743,48 Kč | m |
|  | PR0005/08 | 6-001723-0008 | Válcovaná schránka, úkos 20° GUTS 180 - stříbrná | 506,95 Kč | m |
|  | PR0005/82 | 6-001723-0082 | Válcovaná schránka, úkos 20° GUTS 180 - antracit | 582,45 Kč | m |
|  | PR0030/08 | 6-001725-0008 | Válcovaná schránka, GOT 205 - stříbrná | 767,35 Kč | m |
|  | PR0030/82 | 6-001725-0082 | Válcovaná schránka, GOT 205 - antracit | 1 030,28 Kč | m |
|  | PR0059/08-2 | 6-001755-00082 | Bočnice, 20°, BKS-N 125 -PÁR | 219,53 Kč | ks |
|  | PR0059/82-2 | 6-001755-00822 | Bočnice, 20°, BKS-N 125 -PÁR | 219,53 Kč | ks |

















| | | | | | |
|---|-------------|----------------|--------------------------------|-----------|----|
|  | PR0060/08-2 | 6-001756-00082 | Bočnice, 20°, BKS-N 138 -PÁR | 238,40 Kč | ks |
|  | PR0060/82-2 | 6-001756-00822 | Bočnice, 20°, BKS-N 138 -PÁR | 238,40 Kč | ks |
|  | PR0061/08-2 | 6-001759-00082 | Bočnice, 20°, BKS-N 150 -PÁR | 261,68 Kč | ks |
|  | PR0061/82-2 | 6-001759-00822 | Bočnice, 20°, BKS-N 150 -PÁR | 261,68 Kč | ks |
|  | PR0062/08-2 | 6-001762-00082 | Bočnice, 20°, BKS-N 165 -PÁR | 280,55 Kč | ks |
|  | PR0062/82-2 | 6-001762-00822 | Bočnice, 20°, BKS-N 165 -PÁR | 280,55 Kč | ks |
|  | PR0063/08-2 | 6-001766-00082 | Bočnice, 20°, BKS-N 180 -PÁR | 318,28 Kč | ks |
|  | PR0063/82-2 | 6-001766-00822 | Bočnice, 20°, BKS-N 180 -PÁR | 318,28 Kč | ks |
|  | PR0064/08-2 | 6-001768-00082 | Bočnice, 20°, BKS-N 205 -PÁR | 428,95 Kč | ks |
|  | PR0064/82-2 | 6-001768-00822 | Bočnice, 20°, BKS-N 205 -PÁR | 441,53 Kč | ks |
|  | PR0360/08-2 | 6-001771-00082 | Bočnice, 45°, BKS-N 150 -PÁR | 247,20 Kč | ks |
|  | PR0360/82-2 | 6-001771-00822 | Bočnice, 45°, BKS-N 150 -PÁR | 247,20 Kč | ks |
|  | PR0110/08 | 6-001788-0008 | Vodící lišta A4 STŘÍBRNÁ 08 | 517,00 Kč | m |
|  | PR0110/82 | 6-001788-0082 | Vodící lišta A4 ANTRACIT 82 | 517,00 Kč | m |
|  | PR0170/82 | 6-001794-0082 | Vodící lišta A15 ANTRACIT 82 | 714,53 Kč | m |
|  | PR0205/08 | 6-001808-0008 | Vodící lišta DF A5 STŘÍBRNÁ 08 | 874,25 Kč | m |















| | | | | | |
|---|-------------|----------------|--|-------------|----|
|  | PR0205/82 | 6-001808-0082 | Vodicí lišta DF A5 ANTRACIT 82 | 1 002,63 Kč | m |
|  | PR0077/08 | 6-001852-0008 | Omitací lišta PS-V 20° | 348,48 Kč | m |
|  | PR0077/82 | 6-001852-0082 | Omitací lišta PS-V 20° | 348,48 Kč | m |
|  | PR0361/08 | 6-001861-0008 | Válcovaná schránka, zaoblená ROS 150 - stříbrná | 664,23 Kč | m |
|  | PR0362/08 | 6-001863-0008 | Válcovaná schránka, zaoblená RUS 150 - stříbrná | 922,10 Kč | m |
|  | PR0363/08-2 | 6-001864-00082 | Bočnice, kulatá, BKR-N 150 -PÁR | 313,25 Kč | ks |
|  | PR0065/08-2 | 6-001884-00082 | Bočnice, kulatá, BKR-N 138 -PÁR | 283,05 Kč | ks |
|  | PR0069/08-2 | 6-001885-00082 | Bočnice, čtvrtkulatá, BKVR-N 138 -PÁR | 491,83 Kč | ks |
|  | PR0069/82-2 | 6-001885-00822 | Bočnice, čtvrtkulatá, BKVR-N 138 -PÁR | 491,83 Kč | ks |
|  | PR0031/08 | 6-001886-0008 | Válcovaná schránka, zaoblená ROS 138 - stříbrná | 617,70 Kč | m |
|  | PR0013/08 | 6-001887-0008 | Válcovaná schránka, zaoblená RUS 138 - stříbrná | 495,63 Kč | m |
|  | PR0017/08 | 6-001888-0008 | Válcovaná schránka, čtvrtkulatá VRB 138 - stříbrná | 495,63 Kč | m |
|  | PR0017/82 | 6-001888-0082 | Válcovaná schránka, čtvrtkulatá VRB 138 - antracit | 808,88 Kč | m |
|  | PR0066/08-2 | 6-001889-00082 | Bočnice, kulatá, BKR-N 165 -PÁR | 343,45 Kč | ks |
|  | PR0070/08-2 | 6-001890-00082 | Bočnice, čtvrtkulatá, BKVR-N 165 -PÁR | 581,83 Kč | ks |
|  | PR0070/82-2 | 6-001890-00822 | Bočnice, čtvrtkulatá, BKVR-N 165 -PÁR | 581,83 Kč | ks |





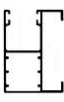





| | | | | | |
|---|-------------|----------------|--|-----------|----|
|  | PR0032/08 | 6-001891-0008 | Válcovaná schránka, zaoblená ROS 165 - stříbrná | 714,53 Kč | m |
|  | PR0014/08 | 6-001892-0008 | Válcovaná schránka, zaoblená RUS 165 - stříbrná | 562,35 Kč | m |
|  | PR0018/08 | 6-001893-0008 | Válcovaná schránka, čtvrtkulatá VRB 165 - stříbrná | 556,05 Kč | m |
|  | PR0018/82 | 6-001893-0082 | Válcovaná schránka, čtvrtkulatá VRB 165 - antracit | 607,63 Kč | m |
|  | PR0071/08-2 | 6-001894-00082 | Bočnice, čtvrtkulatá, BKVR-N 180 -PÁR | 616,40 Kč | ks |
|  | PR0071/82-2 | 6-001894-00822 | Bočnice, čtvrtkulatá, BKVR-N 180 -PÁR | 616,40 Kč | ks |
|  | PR0019/08 | 6-001895-0008 | Válcovaná schránka, čtvrtkulatá VRB 180 - stříbrná | 684,33 Kč | m |
|  | PR0019/82 | 6-001895-0082 | Válcovaná schránka, čtvrtkulatá VRB 180 - antracit | 704,45 Kč | m |
|  | PR0068/08-2 | 6-001896-00082 | Bočnice, kulatá, BKR-N 205 -PÁR | 510,08 Kč | ks |
|  | PR0073/08-2 | 6-001928-00082 | Bočnice, proti hmyzu, 20°, BKS-I-N 138 -PÁR | 280,55 Kč | ks |
|  | PR0073/82-2 | 6-001928-00822 | Bočnice, proti hmyzu, 20°, BKS-I-N 138 -PÁR | 280,55 Kč | ks |
|  | PR0074/08-2 | 6-001930-00082 | Bočnice, proti hmyzu, 20°, BKS-I-N 150 -PÁR | 312,00 Kč | ks |
|  | PR0074/82-2 | 6-001930-00822 | Bočnice, proti hmyzu, 20°, BKS-I-N 150 -PÁR | 312,00 Kč | ks |
|  | PR0075/08-2 | 6-001932-00082 | Bočnice, proti hmyzu, 20°, BKS-I-N 165 -PÁR | 335,90 Kč | ks |
|  | PR0075/82-2 | 6-001932-00822 | Bočnice, proti hmyzu, 20°, BKS-I-N 165 -PÁR | 335,90 Kč | ks |
|  | PR0076/08-2 | 6-001933-00082 | Bočnice, proti hmyzu, 20°, BKS-I-N 180 -PÁR | 370,48 Kč | ks |

| | | | | | |
|---|-------------|----------------|---|-----------|----|
|  | PR0076/82-2 | 6-001933-00822 | Bočnice, proti hmyzu, 20°, BKS-I-N 180 -PÁR | 370,48 Kč | ks |
|  | PR0157/08 | 6-001935-0008 | Ukončovací lišta SLI.2 - STRÍBRNÁ | 288,08 Kč | m |
|  | PR0210/08-2 | 6-002369-00082 | Bočnice, 45°, BKS-N 125 -PÁR | 257,90 Kč | ks |
|  | PR0210/82-2 | 6-002369-00822 | Bočnice, 45°, BKS-N 125 -PÁR | 257,90 Kč | ks |
|  | PR0211/08-2 | 6-002370-00082 | Bočnice, 45°, BKS-N 138 -PÁR | 221,40 Kč | ks |
|  | PR0211/82-2 | 6-002370-00822 | Bočnice, 45°, BKS-N 138 -PÁR | 221,40 Kč | ks |
|  | PR0212/08-2 | 6-002372-00082 | Bočnice, 45°, BKS-N 165 -PÁR | 280,55 Kč | ks |
|  | PR0212/82-2 | 6-002372-00822 | Bočnice, 45°, BKS-N 165 -PÁR | 280,55 Kč | ks |
|  | PR0213/08-2 | 6-002373-00082 | Bočnice, 45°, BKS-N 180 -PÁR | 300,68 Kč | ks |
|  | PR0213/82-2 | 6-002373-00822 | Bočnice, 45°, BKS-N 180 -PÁR | 300,68 Kč | ks |
|  | PR0214/08-2 | 6-002374-00082 | Bočnice, 45°, BKS-N 205 -PÁR | 437,15 Kč | ks |
|  | PR0214/82-2 | 6-002374-00822 | Bočnice, 45°, BKS-N 205 -PÁR | 437,15 Kč | ks |
|  | PR0215/08-2 | 6-002378-00082 | Bočnice, 90°, BK-N 125 -PÁR | 307,58 Kč | ks |
|  | PR0215/82-2 | 6-002378-00822 | Bočnice, 90°, BK-N 125 -PÁR | 307,58 Kč | ks |
|  | PR0216/08-2 | 6-002379-00082 | Bočnice, 90°, BK-N 150 -PÁR | 386,83 Kč | ks |
|  | PR0216/82-2 | 6-002379-00822 | Bočnice, 90°, BK-N 150 -PÁR | 386,83 Kč | ks |

| | | | | | |
|---|-------------|----------------|---------------------------------------|-------------|----|
|  | PR0217/08-2 | 6-002380-00082 | Bočnice, 90°, BK-N 165 -PÁR | 425,83 Kč | ks |
|  | PR0217/82-2 | 6-002380-00822 | Bočnice, 90°, BK-N 165 -PÁR | 425,83 Kč | ks |
|  | PR0218/08-2 | 6-002381-00082 | Bočnice, 90°, BK-N 180 -PÁR | 479,25 Kč | ks |
|  | PR0218/82-2 | 6-002381-00822 | Bočnice, 90°, BK-N 180 -PÁR | 479,25 Kč | ks |
|  | PR0219/08-2 | 6-002382-00082 | Bočnice, 90°, BK-N 205 -PÁR | 531,48 Kč | ks |
|  | PR0219/82-2 | 6-002382-00822 | Bočnice, 90°, BK-N 205 -PÁR | 531,48 Kč | ks |
|  | PR0067/08-2 | 6-002385-00082 | Bočnice, kulatá, BKR-N 180 -PÁR | 393,75 Kč | ks |
|  | PR0220/08-2 | 6-002388-00082 | Bočnice, čtvrtkulatá, BKVR-N 150 -PÁR | 546,60 Kč | ks |
|  | PR0220/82-2 | 6-002388-00822 | Bočnice, čtvrtkulatá, BKVR-N 150 -PÁR | 546,60 Kč | ks |
|  | PR0072/08-2 | 6-002391-00082 | Bočnice, čtvrtkulatá, BKVR-N 205 -PÁR | 740,95 Kč | ks |
|  | PR0072/82-2 | 6-002391-00822 | Bočnice, čtvrtkulatá, BKVR-N 205 -PÁR | 740,95 Kč | ks |
|  | PR0042/08 | 6-002525-0008 | Protlačovaná schránka, RR 165 | 1 118,33 Kč | m |
|  | PR0042/82 | 6-002525-00822 | Protlačovaná schránka, RR 165 | 1 118,33 Kč | m |
|  | PR0040/08 | 6-002531-0008 | Protlačovaná schránka, RR 138 | 646,60 Kč | m |
|  | PR0040/82 | 6-002531-00822 | Protlačovaná schránka, RR 138 | 646,60 Kč | m |
|  | PR0039/08 | 6-002534-0008 | Protlačovaná schránka, RR 125 | 656,68 Kč | m |

| | | | | | |
|---|-----------|---------------|---|-------------|---|
|  | PR0039/82 | 6-002534-0082 | Protlačovaná schránka, RR 125 | 656,68 Kč | m |
|  | PR0201/08 | 6-002537-0008 | Protlačovaná schránka, RR 100 | 532,10 Kč | m |
|  | PR0201/82 | 6-002537-0082 | Protlačovaná schránka, RR 100 | 532,10 Kč | m |
|  | PR0020/08 | 6-002542-0008 | Válcovaná schránka, čtvrtkulatá VRB 205, stříbrná | 742,20 Kč | m |
|  | PR0020/82 | 6-002542-0082 | Válcovaná schránka, čtvrtkulatá VRB 205, antracit | 798,80 Kč | m |
|  | PR0236/08 | 6-002545-0008 | Válcovaná schránka, čtvrtkulatá VRB 150 | 533,35 Kč | m |
|  | PR0236/82 | 6-002545-0082 | Válcovaná schránka, čtvrtkulatá VRB 150 | 545,98 Kč | m |
|  | PR0016/08 | 6-002547-0008 | Válcovaná schránka, zaoblená RUS 205 - stříbrná | 743,48 Kč | m |
|  | PR0016/82 | 6-002547-0082 | Válcovaná schránka, zaoblená RUS 205 - antracit | 1 114,58 Kč | m |
|  | PR0034/08 | 6-002548-0008 | Válcovaná schránka, zaoblená ROS 205 - stříbrná | 1 083,13 Kč | m |
|  | PR0034/82 | 6-002548-0082 | Válcovaná schránka, zaoblená ROS 205 - antracit | 1 070,55 Kč | m |
|  | PR0015/08 | 6-002549-0008 | Válcovaná schránka, zaoblená RUS 180 - stříbrná | 617,70 Kč | m |
|  | PR0033/08 | 6-002550-0008 | Válcovaná schránka, zaoblená ROS 180 - stříbrná | 761,05 Kč | m |
|  | PR0245/08 | 6-002565-0008 | Válcovaná schránka, úkos 45° GSUT 205 | 630,28 Kč | m |
|  | PR0245/82 | 6-002565-0082 | Válcovaná schránka, úkos 45° GSUT 205 | 743,48 Kč | m |
|  | PR0246/08 | 6-002566-0008 | Válcovaná schránka, úkos 45° GSUT 180 | 506,95 Kč | m |

| | | | | | |
|---|-------------|----------------|---|-----------|----|
|  | PR0246/82 | 6-002566-0082 | Válcovaná schránka, úkos 45° GSUT 180 | 582,45 Kč | m |
|  | PR0247/08 | 6-002567-0008 | Válcovaná schránka, úkos 45°, GSUT 165 | 475,50 Kč | m |
|  | PR0247/82 | 6-002567-0082 | Válcovaná schránka, úkos 45°, GSUT 165 | 567,38 Kč | m |
|  | PR0248/08 | 6-002568-0008 | Válcovaná schránka, úkos 45°, GSUT 150 | 430,23 Kč | m |
|  | PR0248/82 | 6-002568-0082 | Válcovaná schránka, úkos 45°, GSUT 150 | 514,50 Kč | m |
|  | PR0249/08 | 6-002569-0008 | Válcovaná schránka, úkos 45°, GSUT 138 | 366,05 Kč | m |
|  | PR0249/82 | 6-002569-0082 | Válcovaná schránka, úkos 45°, GSUT 138 | 656,68 Kč | m |
|  | PR0250/08 | 6-002570-0008 | Válcovaná schránka, úkos 45°, GSUT 125 | 353,48 Kč | m |
|  | PR0250/82 | 6-002570-0082 | Válcovaná schránka, úkos 45°, GSUT 125 | 632,78 Kč | m |
|  | PR0252/08-2 | 6-002598-00082 | Bočnice, 90°, BK-N 138 -PÁR | 379,93 Kč | ks |
|  | PR0252/82-2 | 6-002598-00822 | Bočnice, 90°, BK-N 138 -PÁR | 379,93 Kč | ks |
|  | PR0188/08 | 6-002599-0008 | Vodící lišta A8-12 STRÍBRNÁ 08 | 517,00 Kč | m |
| | PR0114/08 | 6-002601-0008 | Vodící lišta DF A3 STRÍBRNÁ 08 | 904,50 Kč | m |
|  | PR0263/08-2 | 6-002794-00082 | Bočnice, proti hmyzu, 45°, BKS-I-N 138 -PÁR | 280,55 Kč | ks |
|  | PR0263/82-2 | 6-002794-00822 | Bočnice, proti hmyzu, 45°, BKS-I-N 138 -PÁR | 330,23 Kč | ks |
|  | PR0264/08-2 | 6-002795-00082 | Bočnice, proti hmyzu, 45°, BKS-I-N 150 -PÁR | 312,00 Kč | ks |

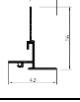
| | | | | | |
|---|-------------|----------------|---|-----------|----|
|  | PR0264/82-2 | 6-002795-00822 | Bočnice, proti hmyzu, 45°, BKS-I-N 150 -PÁR | 367,35 Kč | ks |
|  | PR0265/08-2 | 6-002798-00082 | Bočnice, proti hmyzu, 45°, BKS-I-N 165 -PÁR | 335,90 Kč | ks |
|  | PR0265/82-2 | 6-002798-00822 | Bočnice, proti hmyzu, 45°, BKS-I-N 165 -PÁR | 389,95 Kč | ks |
|  | PR0266/08-2 | 6-002799-00082 | Bočnice, proti hmyzu, 45°, BKS-I-N 180 -PÁR | 370,48 Kč | ks |
|  | PR0266/82-2 | 6-002799-00822 | Bočnice, proti hmyzu, 45°, BKS-I-N 180 -PÁR | 435,23 Kč | ks |
|  | PR0192/08 | 6-008229-0008 | Protlačovaná schránka, úkos 20°, RK 205, spodní | 812,65 Kč | m |
|  | PR0192/82 | 6-008229-0082 | Protlačovaná schránka, úkos 20°, RK 205, spodní | 812,65 Kč | m |
|  | PR0202/08 | 6-010131-0008 | Protlačová schránka, RR 90 | 464,18 Kč | m |
|  | PR0202/82 | 6-010131-0082 | Protlačová schránka, RR 90 | 464,18 Kč | m |
|  | PR0359/08 | 6-012011-0008 | Omitací lišta PS-V 90° | 427,70 Kč | m |
|  | PR0359/82 | 6-012011-0082 | Omitací lišta PS-V 90° | 427,70 Kč | m |
| | NRS0100 | 6-016273-0100 | Narážecí stopka 28mm - bílá | 30,20 Kč | ks |
| | NRS0200 | 6-016273-0200 | Narážecí stopka 28mm - hnědá | 30,20 Kč | ks |
| | NRS0300 | 6-016273-0300 | Narážecí stopka 28mm - šedá | 30,20 Kč | ks |
| | NRS0400 | 6-016273-0400 | Narážecí stopka 28mm - černá | 30,20 Kč | ks |
| | NRS0600 | 6-016273-0600 | Narážecí stopka 28mm - béžová | 30,20 Kč | ks |